



prēmoulē



C35S - White - Satin

**THERMOPLASTIC
DOORS AND
COMPONENTS**

Custom program

R32S - Black - Super Matte



DOOR MODELS

- 04 Slab
- 06 Shaker
- 14 Standard
- 28 Special
- 33 Mitred 45° rail 7000 series



OPTIONS, MOULDINGS AND ACCESSORIES

- 35 Grooves on centre panels
- 36 Panels
- 38 Frames and Mullions
- 40 Mouldings and accessories
- 46 Technical specifications
- 48 Colours and finishes
- 51 Finish and colour chart / Prémoulé compatible colour options
- 53 High Brilliance Collection
- 54 Warranty



Design

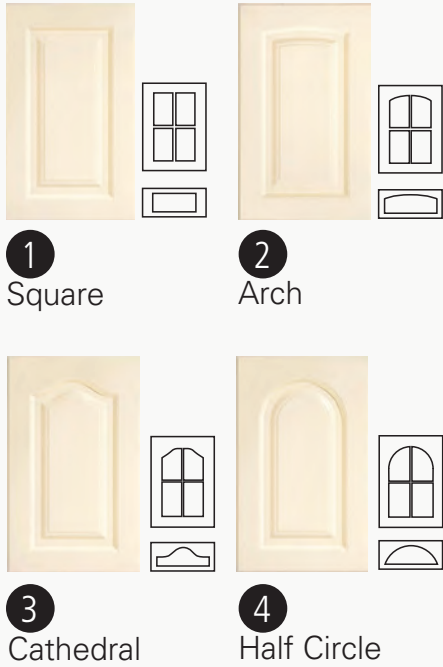

Interior Profiles

Certain interior profiles are available with Pro-Teint Italian Lacquer, please refer to Customer Service for more information.

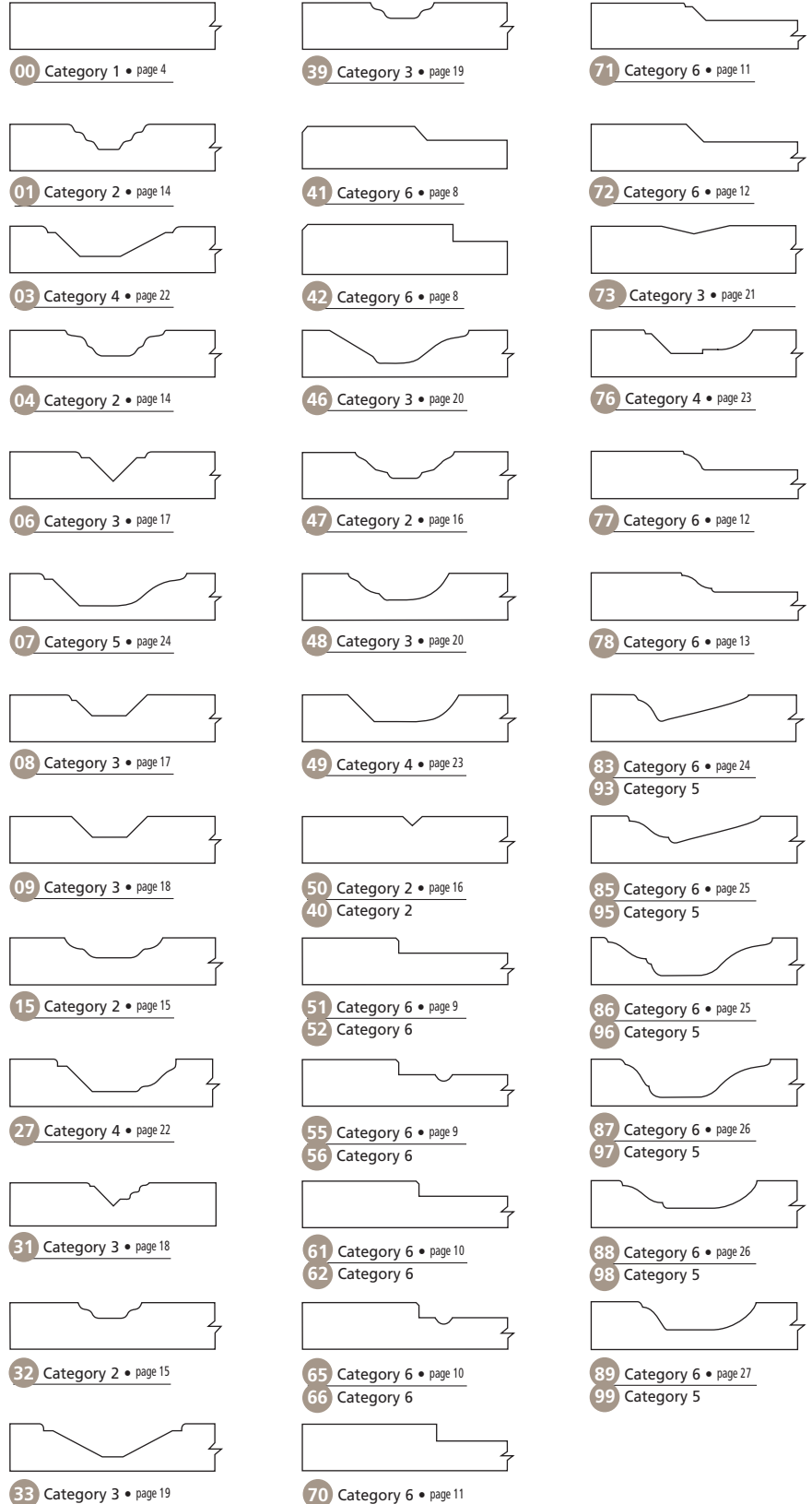

Model 207
Colour: F435WT



Grooves optional. Details on page 35.

SPECIAL PROGRAMMING

Prémoulé manufactures custom door models to certain specifications.
Please contact a Customer Service Representative for further information.

Exterior Profiles

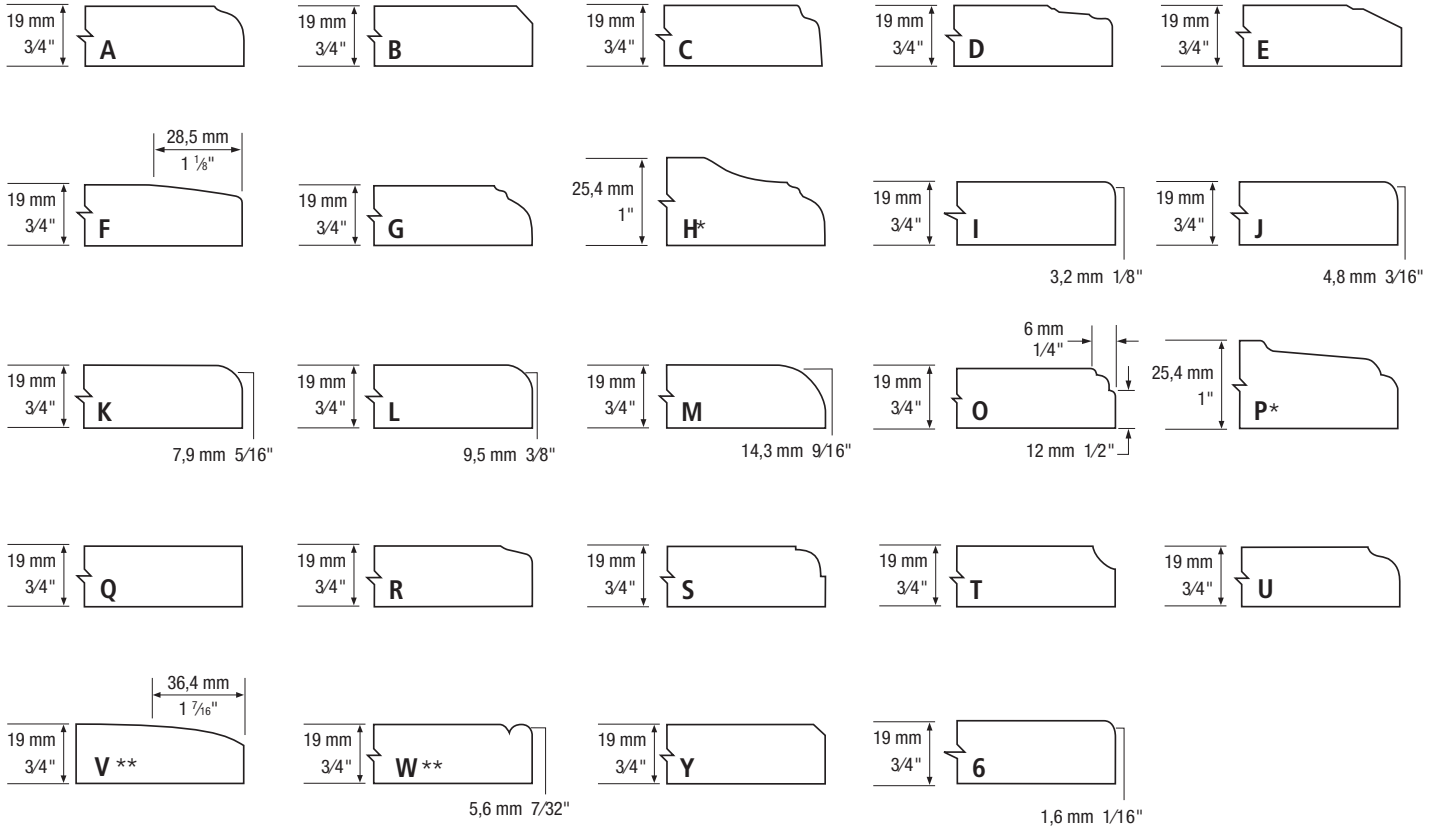

* Exterior profiles H and P available with MDF (only 1").

** Exterior profiles V and W available with an upcharge.

SPECIAL MODELS



Model **164** Cat. 4
Colour: R207W
Page 6



Model **167** Cat. 4
Colour: R207W
Page 6



Model **764-767** Cat. 5
Colour: P340W
Page 7



Model **910** Cat. 6
Colour: F44W
Page 32



Model **911** Cat. 3
Colour: C92W
Page 30



Model **912** Cat. 3
Colour: C92W
Page 21



Model **921** Cat. 3
Colour: C72R
Page 30



Model **928** Premium
Colour: R205W
Page 29



Model **942** Cat. 6
Colour: R205W
Page 13



Model **943** Premium
Colour: F434WT
Page 28



Model **944** Premium
Colour: A3WT
Page 28



Model **972** Cat. 4
Colour: C92W
Page 31



Model **974** Cat. 4
Colour: C72R
Page 31



Model **996** Cat. 3
Colour: A24WT
Page 32

SERIES 00 Category 1

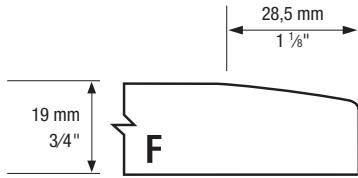

Model 000 minimum sizes are determined by the exterior profile selected:

DOORS AND DRAWER FRONTS

EXTERIOR PROFILE	(Height x Width)	
	mm	inches
A, B, C, G, I, J, K, L, M, O, Q, R, S, T, U, V, Y, 6	38.1 x 38.1	1 1/2 x 1 1/2
D, E, W	50.8 x 50.8	2 x 2
F	76.2 x 76.2	3 x 3
H	82.6 x 82.6	3 1/4 x 3 1/4
P	90.5 x 90.5	3 9/16 x 3 9/16

Minimum charges apply for thermoplastic pieces less than 76.2 mm (3") in height (or width).

Products: 2000 and 3000

Length: 1.828 m to 2.438 m (72" to 96")

Width: less than 76.2 mm (3")

Minimum charge: 1 sq ft

Model **00F**

Colour: R205W

SERIES 00 Category 1

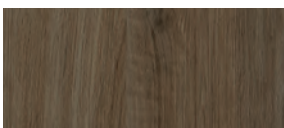
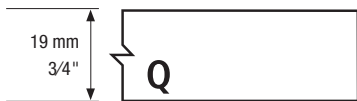

Model 000 minimum sizes are determined by the exterior profile selected:

DOORS AND DRAWER FRONTS

EXTERIOR PROFILE	(Height x Width)	
	mm	inches
A, B, C, G, I, J, K, L, M, O, Q, R, S, T, U, V, Y, 6	38.1 x 38.1	1 1/2 x 1 1/2
D, E, W	50.8 x 50.8	2 x 2
F	76.2 x 76.2	3 x 3
H	82.6 x 82.6	3 1/4 x 3 1/4
P	90.5 x 90.5	3 9/16 x 3 9/16

Minimum charges apply for thermoplastic pieces less than 76.2 mm (3") in height (or width).

Products: 2000 and 3000

Length: 1.828 m to 2.438 m (72" to 96")

Width: less than 76.2 mm (3")

Minimum charge: 1 sq ft

Model **00Q**

Colour: F435WT

STANDARD FEATURES

- White melamine back
- Woodgrain pattern direction always runs vertically to height, unless specified otherwise

- Shaker drawer fronts are manufactured with regular rails (unless reduced rails are specified)
- Maximum door height: 2438 mm (96"), maximum door width: 1193 mm (47")

SERIES 00 Category 1

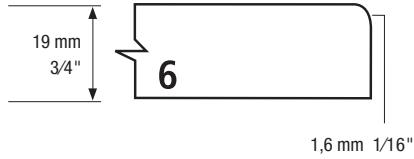

Model 000 minimum sizes are determined by the exterior profile selected:

DOORS AND DRAWER FRONTS

EXTERIOR PROFILE	(Height x Width)	
	mm	inches
A, B, C, G, I, J, K, L, M, O, Q, R, S, T, U, V, Y, 6	38.1 x 38.1	1 1/2 x 1 1/2
D, E, W	50.8 x 50.8	2 x 2
F	76.2 x 76.2	3 x 3
H	82.6 x 82.6	3 1/4 x 3 1/4
P	90.5 x 90.5	3 9/16 x 3 9/16

Minimum charges apply for thermoplastic pieces less than 76.2 mm (3") in height (or width).

Products: 2000 and 3000

Length: 1.828 m to 2.438 m (72" to 96")

Width: less than 76.2 mm (3")

Minimum charge: 1 sq ft

Model **006**

Colour: V393WT

SERIES 00 Category 2

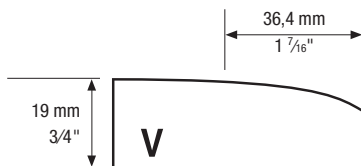

Model 000 minimum sizes are determined by the exterior profile selected:

DOORS AND DRAWER FRONTS

EXTERIOR PROFILE	(Height x Width)	
	mm	inches
A, B, C, G, I, J, K, L, M, O, Q, R, S, T, U, V, Y, 6	38.1 x 38.1	1 1/2 x 1 1/2
D, E, W	50.8 x 50.8	2 x 2
F	76.2 x 76.2	3 x 3
H	82.6 x 82.6	3 1/4 x 3 1/4
P	90.5 x 90.5	3 9/16 x 3 9/16

Minimum charges apply for thermoplastic pieces less than 76.2 mm (3") in height (or width).

Products: 2000 and 3000

Length: 1.828 m to 2.438 m (72" to 96")

Width: less than 76.2 mm (3")

Minimum charge: 1 sq ft

Model **00V**

Colour: P492W

SERIES 164 Category 4

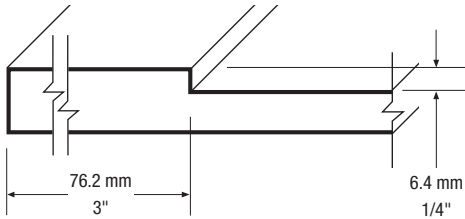

Regular rail

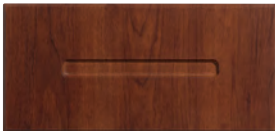

Reduced rail



Minimum sizes

DOORS AND DRAWERS (Height x Width)

MODEL	mm	inches
164	177.8 x 177.8	7 x 7

REDUCED DRAWER FRONTS (Height x Width)

MODEL	mm	inches
164 red	76.2 x 177.8	3 x 7

red = reduced
Default exterior profile: Y

Model 164 drawer fronts come standard with full top and bottom rails.

If reduced rail drawer fronts are required, it must be specified when placing your order.

Model 164

Colour: R207W

SERIES 167 Category 4

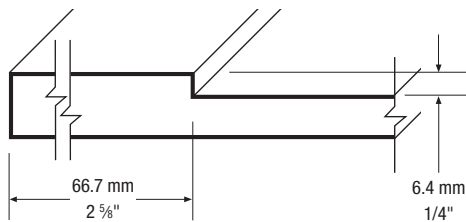

Regular rail



Reduced rail



Minimum sizes

DOORS AND DRAWERS (Height x Width)

MODEL	mm	inches
167	158.8 x 158.8	6 1/4 x 6 1/4

REDUCED DRAWER FRONTS (Height x Width)

MODEL	mm	inches
167red	76.2 x 158.8	3 x 6 1/4

red = reduced
Default exterior profile: Y

Model 167 drawer fronts come standard with full top and bottom rails.

If reduced rail drawer fronts are required, it must be specified when placing your order.

Model 167

Colour: R207W

STANDARD FEATURES

- White melamine back
- Woodgrain pattern direction always runs vertically to height, unless specified otherwise
- Shaker drawer fronts are manufactured with regular rails (unless reduced rails are specified)
- Maximum door height: 2438 mm (96"), maximum door width: 1193 mm (47")

SERIES 764 Category 5

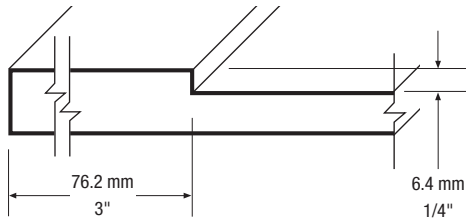

Regular rail



Reduced rail



Minimum sizes

DOORS AND DRAWERS (Height x Width)

MODEL	mm	inches
764	177.8 x 177.8	7 x 7

REDUCED DRAWER FRONTS (Height x Width)

MODEL	mm	inches
764red	76.2 x 177.8	3 x 7

red = reduced

Default exterior profile Y

Series 764 drawer fronts come standard with full top and bottom rails.

If reduced rail drawer fronts are required, it must be specified when placing your order.

Model **764**

Colour: P340W

SERIES 767 Category 5

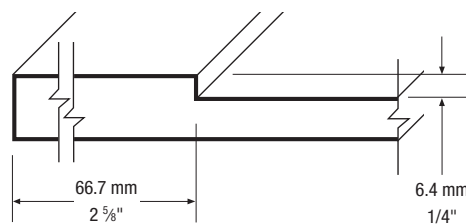

Regular rail



Reduced rail



Minimum sizes

DOORS AND DRAWERS (Height x Width)

MODEL	mm	inches
767	158.8 x 158.8	6 1/4 x 6 1/4

REDUCED DRAWER FRONTS (Height x Width)

MODEL	mm	inches
767red	76.2 x 158.8	3 x 6 1/4

red = reduced

Default exterior profile: Y

Series 767 drawer fronts come standard with full top and bottom rails.

If reduced rail drawer fronts are required, it must be specified when placing your order.

Model **767**

Colour: P340W

SERIES 41 Category 6

41 | Shaker cut

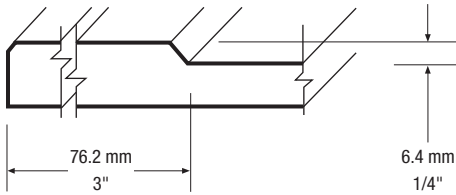

Regular rail



Reduced rail



Minimum sizes

DOORS AND DRAWERS (Height x Width)

MODEL	mm	inches
141	177.8 x 177.8	7 x 7

REDUCED DRAWER FRONTS (Height x Width)

MODEL	mm	inches
141red	101.6 x 177.8	4 x 7

red = Reduced rail
Default exterior profile: Y

Series 141 drawer fronts come standard with full top and bottom rails.

If reduced rail drawer fronts are required, it must be specified when placing your order.

Model **141**

Colour: A24WT

SERIES 42 Category 6

42 | Shaker cut

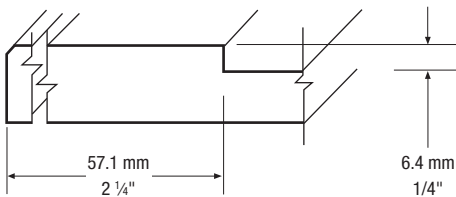

Regular rail

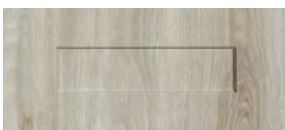

Reduced rail

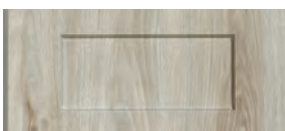

Minimum sizes

DOORS AND DRAWERS (Height x Width)

MODEL	mm	inches
142	139.7 x 139.7	5 1/2 x 5 1/2

REDUCED DRAWER FRONTS (Height x Width)

MODEL	mm	inches
142red	101.6 x 139.7	4 x 5 1/2

red = Reduced rail
Default exterior profile: Y

Series 142 drawer fronts come standard with full top and bottom rails.

If reduced rail drawer fronts are required, it must be specified when placing your order.

Model **142**

Colour: K02W

STANDARD FEATURES

- White melamine back
- Woodgrain pattern direction always runs vertically to height, unless specified otherwise

- Shaker drawer fronts are manufactured with regular rails (unless reduced rails are specified)
- Maximum door height: 2438 mm (96"), maximum door width: 1193 mm (47")

SERIES 51 Category 6

51 | Shaker cut

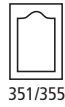
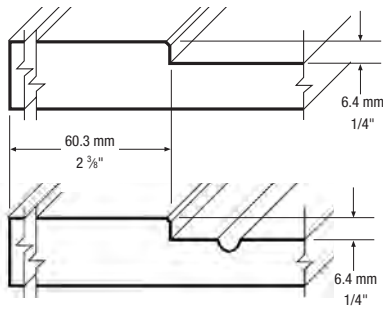

55 | Shaker cut with grooves



Minimum sizes

DOORS AND DRAWERS (Height x Width)

MODEL	mm	inches
151/55	146.0 x 146.0	5 3/4 x 5 3/4
251/55	161.0 x 146.0	6 11/32 x 5 3/4
351/55	186.0 x 200.6	7 11/32 x 7 29/32
451/55	$((W \div 2) + 99.5) \times 146.0$	$((W \div 2) + 3 15/16) \times 5 3/4$

REDUCED DRAWER FRONTS (Height x Width)

MODEL	mm	inches
151/55red	76.2 x 146.0	3 x 5 3/4
251/55red	91.2 x 146.0	3 19/32 x 5 3/4
351/55red	116.2 x 200.6	4 9/16 x 7 7/8
451/55red	$((W \div 2) + 29.7) \times 146.0$	$((W \div 2) + 1 5/32) \times 5 3/4$

red = reduced

W = width

Default exterior profile: Y

Series 51 and 55 drawer fronts come standard with full top and bottom rails. If reduced rail drawer fronts are required, it must be specified when placing your order.



55

Category 6

Model **151**
Colour: R205W

Model **155**
Colour: R205W

SERIES 52 Category 6

52 | Shaker cut

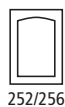
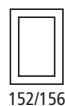
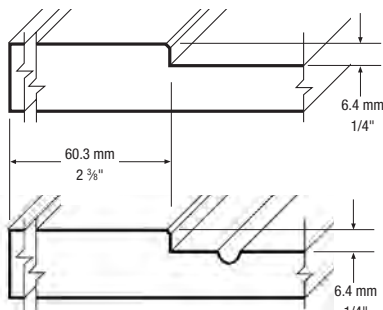

56 | Shaker cut with grooves



Minimum sizes

DOORS AND DRAWERS (Height x Width)

MODEL	mm	inches
152/56	146.0 x 146.0	5 3/4 x 5 3/4
252/56	161.0 x 146.0	6 11/32 x 5 3/4
352/56	186.0 x 200.6	7 11/32 x 7 7/8
452/56	$((W \div 2) + 99.5) \times 146.0$	$((W \div 2) + 3 29/32) \times 5 3/4$

REDUCED DRAWER FRONTS (Height x Width)

MODEL	mm	inches
152/56red	76.2 x 146.0	3 x 5 3/4
252/56red	91.2 x 146.0	3 19/32 x 5 3/4
352/56red	116.2 x 200.6	4 9/16 x 7 7/8
452/56red	$((W \div 2) + 29.7) \times 146.0$	$((W \div 2) + 1 5/32) \times 5 3/4$

red = reduced

W = width

Default exterior profile: Y

Series 52 and 56 drawer fronts come standard with full top and bottom rails. If reduced rail drawer fronts are required, it must be specified when placing your order.

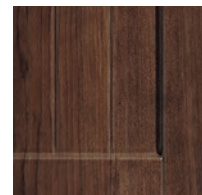

56

Category 6

Model **152**
Colour: R207W

Model **156**
Colour: R207W

SERIES 61 Category 6

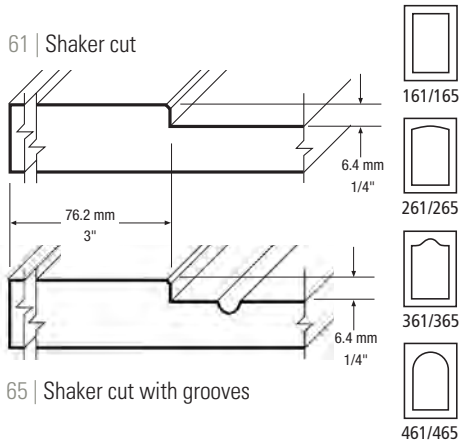

65 | Shaker cut with grooves

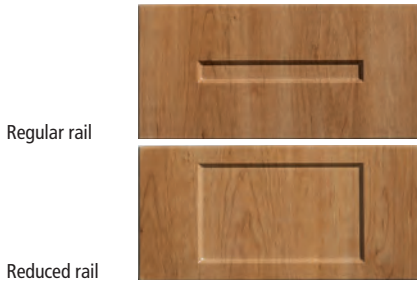

Minimum sizes

DOORS AND DRAWERS (Height x Width)

MODEL	mm	inches
161/65	177.8 x 177.8	7 x 7
261/65	192.8 x 177.8	7 19/32 x 7
361/65	217.8 x 232.4	8 19/32 x 9 5/32
461/65	$((W \div 2) + 115.4) \times 177.8$	$((W \div 2) + 4 9/16) \times 7$

REDUCED DRAWER FRONTS (Height x Width)

MODEL	mm	inches
161/65red	76.2 x 177.8	3 x 7
261/65red	91.2 x 177.8	3 19/32 x 7
361/65red	116.2 x 232.4	4 19/32 x 9 5/32
461/65red	$((W \div 2) + 13.8) \times 177.8$	$((W \div 2) + 9/16) \times 7$

red = reduced

W = width

Default exterior profile: Y

Series 61 and 65 drawer fronts come standard with full top and bottom rails. If reduced rail drawer fronts are required, it must be specified when placing your order.



65

Category 6

Model **161**
Colour: R205W

Model **165**
Colour: R205W

SERIES 62 Category 6

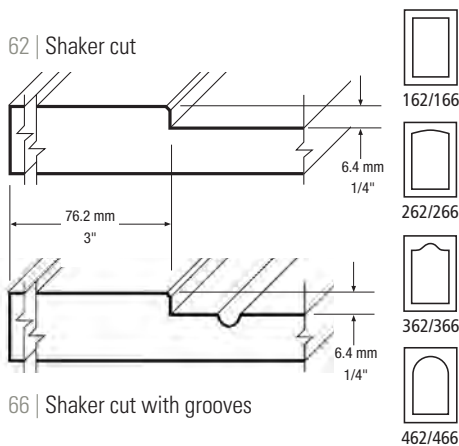

66 | Shaker cut with grooves

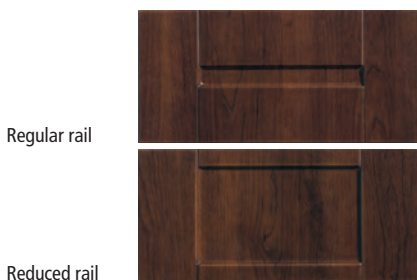

Minimum sizes

DOORS AND DRAWERS (Height x Width)

MODEL	mm	inches
162/66	177.8 x 177.8	7 x 7
262/66	192.8 x 177.8	7 19/32 x 7
362/66	217.8 x 232.4	8 19/32 x 9 5/32
462/66	$((W \div 2) + 115.4) \times 177.8$	$((W \div 2) + 4 9/16) \times 7$

REDUCED DRAWER FRONTS (Height x Width)

MODEL	mm	inches
162/66red	76.2 x 177.8	3 x 7
262/66red	91.2 x 177.8	3 19/32 x 7
362/66red	116.2 x 232.4	4 19/32 x 9 5/32
462/66red	$((W \div 2) + 13.8) \times 177.8$	$((W \div 2) + 9/16) \times 7$

red = Reduced rail

W = width

Default exterior profile: Y

Series 62 and 66 drawer fronts come standard with full top and bottom rails. If reduced rail drawer fronts are required, it must be specified when placing your order.

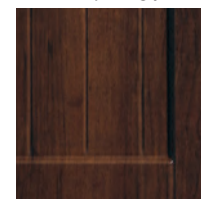

66

Category 6

Model **162**
Colour: R207W

Model **166**
Colour: R207W

STANDARD FEATURES

- White melamine back
- Woodgrain pattern direction always runs vertically to height, unless specified otherwise

- Shaker drawer fronts are manufactured with regular rails (unless reduced rails are specified)
- Maximum door height: 2438 mm (96"), maximum door width: 1193 mm (47")

SERIES 70 Category 6

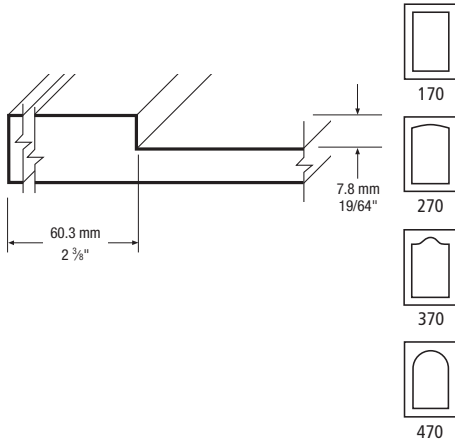

Regular rail



Reduced rail



Minimum sizes

DOORS AND DRAWERS (Height x Width)

MODEL	mm	inches
170	146.0 x 146.0	5 3/4 x 5 3/4
270	161.0 x 146.0	6 11/32 x 5 3/4
370	186.0 x 200.6	7 11/32 x 7 29/32
470	$((W \div 2) + 99.5) \times 146.0$	$((W \div 2) + 3 31/32) \times 5 3/4$

DRAWER FRONTS with reduced rails (Height x Width)

MODEL	mm	inches
170 red	76.2 x 146.0	3 x 5 3/4
270 red	91.2 x 146.0	3 19/32 x 5 3/4
370 red	116.2 x 200.6	4 9/16 x 7 7/8
470 red	$((W \div 2) + 29.7) \times 146.0$	$((W \div 2) + 1 11/64) \times 5 3/4$

W = width

Default exterior profile: B

Series 70 drawer fronts come standard with full top and bottom rails.

If reduced rail drawer fronts are required, it must be specified when placing your order.

Model 170

Colour: C92W

SERIES 71 Category 6

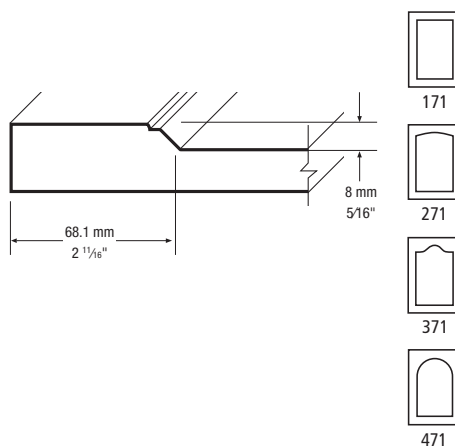

Regular rail



Reduced rail



Minimum sizes

DOORS AND DRAWERS (Height x Width)

MODEL	mm	inches
171	161.6 x 161.6	6 3/8 x 6 3/8
271	176.6 x 161.6	6 31/32 x 6 3/8
371	201.6 x 201.8	7 15/16 x 7 31/32
471	$((W \div 2) + 82.5) \times 161.6$	$((W \div 2) + 3 1/4) \times 6 3/8$

DRAWER FRONTS with reduced rails (Height x Width)

MODEL	mm	inches
171red	102.0 x 161.6	4 1/64 x 6 3/8
271red	117.0 x 161.6	4 39/64 x 6 3/8
371red	142.0 x 201.8	5 19/32 x 7 31/32
471red	$((W \div 2) + 22.9) \times 161.6$	$((W \div 2) + 29/32) \times 6 3/8$

W = width

Default exterior profile: B

Inside cut of series 03

Series 71 drawer fronts come standard with full top and bottom rails.

If reduced rail drawer fronts are required, it must be specified when placing your order.

Model 171

Colour: A15WT

SERIES 72 Category 6

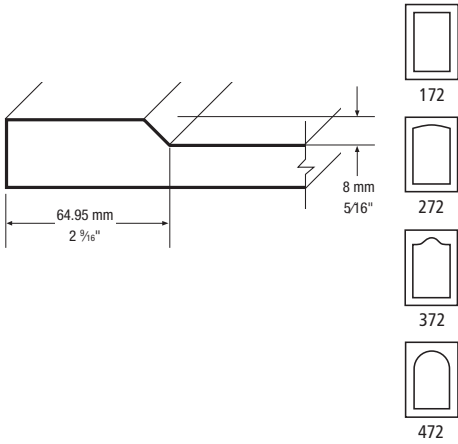

Minimum sizes

DOORS AND DRAWERS (Height x Width)

MODEL	mm	inches
172	155.3 x 155.3	6 1/8 x 6 1/8
272	170.3 x 155.3	6 23/32 x 6 1/8
372	195.3 x 193.9	7 23/32 x 7 21/32
472	((W÷2) + 79.8) x 155.3	((W÷2) + 3 1/8) x 6 1/8

DRAWER FRONTS with reduced rails (Height x Width)

MODEL	mm	inches
172red	91.3 x 155.3	3 5/8 x 6 1/8
272red	106.3 x 155.3	4 3/16 x 6 1/8
372red	131.3 x 193.9	5 3/16 x 7 21/32
472red	((W÷2) + 15.4) x 155.3	((W÷2) + 39/64) x 6 1/8

W = width

Default exterior profile: B

Serie 09 interior profile

Series 72 drawer fronts come standard with full top and bottom rails.

If reduced rail drawer fronts are required, it must be specified when placing your order.

Model 172

Colour: C92W

SERIES 77 Category 6

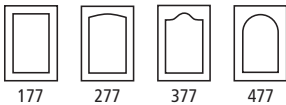
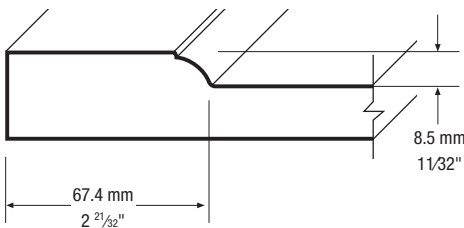

Minimum sizes

DOORS AND DRAWERS (Height x Width)

MODEL	mm	inches
177	179.8 x 179.8	7 3/32 x 7 3/32
277	194.8 x 179.8	7 11/16 x 7 3/32
377	219.8 x 214.8	8 21/32 x 8 15/32
477	((W÷2) + 112.5) x 179.8	((W÷2) + 4 7/16) x 7 3/32

DRAWER FRONTS with reduced rails (Height x Width)

MODEL	mm	inches
177red	116.6 x 179.8	4 19/32 x 7 3/32
277red	131.6 x 179.8	5 3/16 x 7 3/32
377red	156.6 x 214.8	6 3/16 x 8 15/32
477red	((W÷2) + 49.3) x 179.8	((W÷2) + 1 31/32) x 7 3/32

W = width

Default exterior profile: C

Serie 83 interior profile

Series 77 drawer fronts come standard with full top and bottom rails.

If reduced rail drawer fronts are required, it must be specified when placing your order.

Model 177

Colour: F20W

STANDARD FEATURES

- White melamine back
- Woodgrain pattern direction always runs vertically to height, unless specified otherwise
- Shaker drawer fronts are manufactured with regular rails (unless reduced rails are specified)
- Maximum door height: 2438 mm (96"), maximum door width: 1193 mm (47")

SERIES 78 Category 6

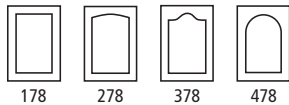
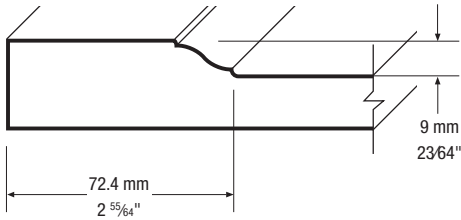

Regular rail



Reduced rail



Minimum sizes

DOORS AND DRAWERS (Height x Width)

MODEL	mm	inches
178	189.8 x 189.8	7 1/2 x 7 1/2
278	204.8 x 189.8	8 3/32 x 7 1/2
378	229.8 x 224.8	9 1/16 x 8 7/8
478	$((W \div 2) + 117.5) \times 189.8$	$((W \div 2) + 4 21/32) \times 7 1/2$

DRAWER FRONTS with reduced rails (Height x Width)

MODEL	mm	inches
178red	126.6 x 189.8	5 x 7 1/2
278red	141.6 x 189.8	5 19/32 x 7 1/2
378red	166.6 x 224.8	6 9/16 x 8 7/8
478red	$((W \div 2) + 54.3) \times 189.8$	$((W \div 2) + 2 5/32) \times 7 1/2$

W = width

Default exterior profile: C

Serie 85 interior profile

Series 78 drawer fronts come standard with full top and bottom rails.

If reduced rail drawer fronts are required, it must be specified when placing your order.

Model **178**

Colour: R766W

SERIES 942 Category 6

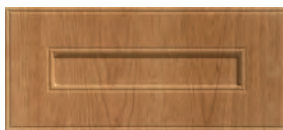
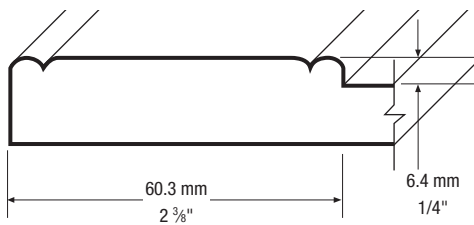

Regular rail



Reduced rail



Minimum sizes

DOORS AND DRAWERS (Height x Width)

MODEL	mm	inches
942	146.0 x 146.0	5 3/4 x 5 3/4

REDUCED DRAWER FRONTS (Height x Width)

MODEL	mm	inches
942red	76.2 x 146.0	3 x 5 3/4

red = Reduced rail

Default exterior profile: W

Series 942 drawer fronts come standard with full top and bottom rails. If reduced rail drawer fronts are required, it must be specified when placing your order.

Model **942**

Colour: R205W

SERIES 01 Category 2

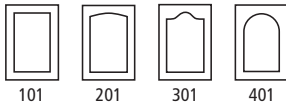
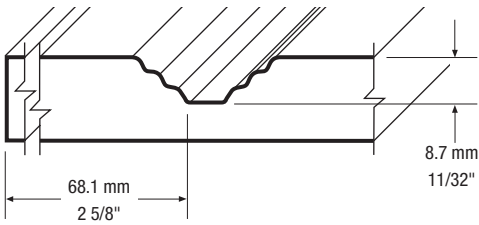

Minimum sizes

DOORS (Height x Width)

MODEL	mm	inches
101	182.8 x 182.8	7 ⁷ / ₃₂ x 7 ⁷ / ₃₂
201	201.3 x 182.8	7 ¹⁵ / ₁₆ x 7 ⁷ / ₃₂
301	222.8 x 182.8	8 ²⁵ / ₃₂ x 7 ⁷ / ₃₂
401	$((W \div 2) + 71.6) \times 182.8$	$((W \div 2) + 2 27/32) \times 7 7/32$

DRAWER (Height x Width)

MODEL	mm	inches
101	120.2 x 182.8	4 ³ / ₄ x 7 ⁷ / ₃₂
201	138.7 x 182.8	5 ¹⁵ / ₃₂ x 7 ⁷ / ₃₂
301	160.2 x 182.8	6 ⁵ / ₁₆ x 7 ⁷ / ₃₂
401	$((W \div 2) + 9.0) \times 182.8$	$((W \div 2) + 3/8) \times 7 7/32$

W = width
Default exterior profile: C

Model **101**
Colour: C92W

SERIES 04 Category 2

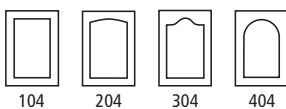
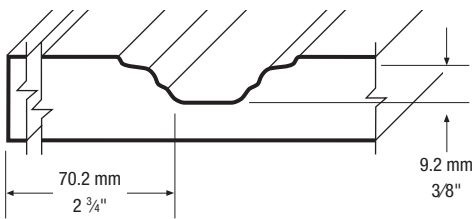

Minimum sizes

DOORS (Height x Width)

MODEL	mm	inches
104	199.0 x 199.0	7 ²⁷ / ₃₂ x 7 ²⁷ / ₃₂
204	214.0 x 199.0	8 ⁷ / ₁₆ x 7 ²⁷ / ₃₂
304	239.0 x 199.0	9 ⁷ / ₁₆ x 7 ²⁷ / ₃₂
404	$((W \div 2) + 75.1) \times 199.0$	$((W \div 2) + 2 31/32) \times 7 27/32$

DRAWER (Height x Width)

MODEL	mm	inches
104	136.4 x 199.0	5 ³ / ₈ x 7 ²⁷ / ₃₂
204	151.4 x 199.0	5 ³¹ / ₃₂ x 7 ²⁷ / ₃₂
304	179.4 x 199.0	7 ³ / ₃₂ x 7 ²⁷ / ₃₂
404	$((W \div 2) + 12.5) \times 199.0$	$((W \div 2) + 1/2) \times 7 27/32$

W = width
Default exterior profile: C

Model **104**
Colour: C92W

STANDARD FEATURES

- White melamine back
- Woodgrain pattern direction always runs vertically to height, unless specified otherwise

- Drawer fronts are manufactured with reduced rails unless specified
- Maximum door height: 2438 mm (96"), maximum door width: 1193 mm (47")

SERIES 15 Category 2

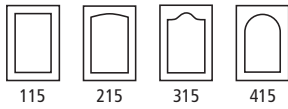
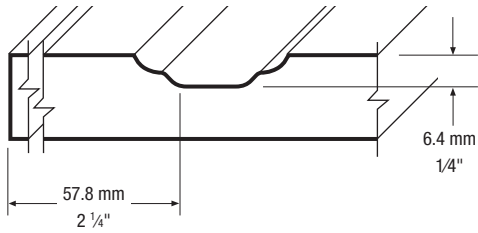

Minimum sizes

DOORS (Height x Width)

MODEL	mm	inches
115	170.5 x 170.5	6 ²³ / ₃₂ x 6 ²³ / ₃₂
215	185.8 x 170.5	7 ¹¹ / ₃₂ x 6 ²³ / ₃₂
315	210.5 x 170.5	8 ⁵ / ₁₆ x 6 ²³ / ₃₂
415	$((W \div 2) + 63.1) \times 170.5$	$((W \div 2) + 2 \frac{1}{2}) \times 6 \frac{23}{32}$

DRAWER fronts (Height x Width)

MODEL	mm	inches
115	127.1 x 170.5	5 ¹ / ₃₂ x 6 ²³ / ₃₂
215	142.1 x 170.5	5 ⁵ / ₈ x 6 ²³ / ₃₂
315	167.1 x 170.5	6 ¹⁹ / ₃₂ x 6 ²³ / ₃₂
415	$((W \div 2) + 19.7) \times 170.5$	$((W \div 2) + \frac{25}{32}) \times 6 \frac{23}{32}$

W = width

Default exterior profile: U

Model **115**

Colour: A4WT

SERIES 32 Category 2

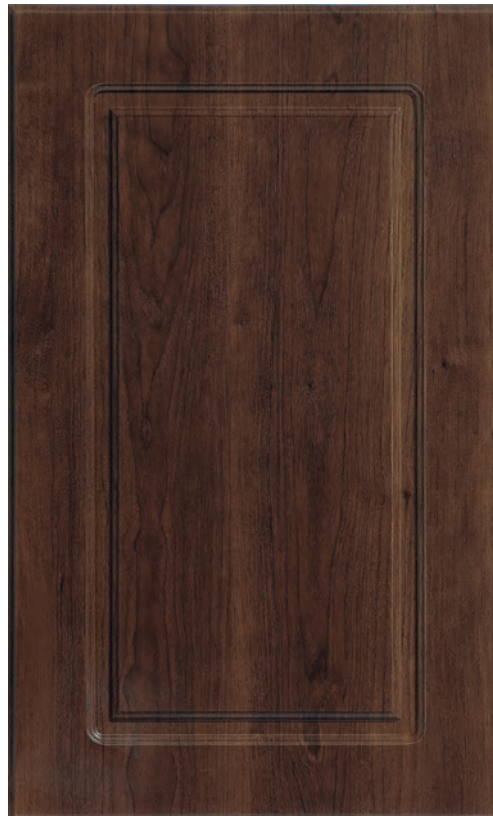
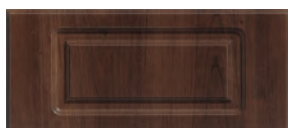
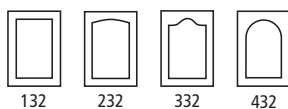
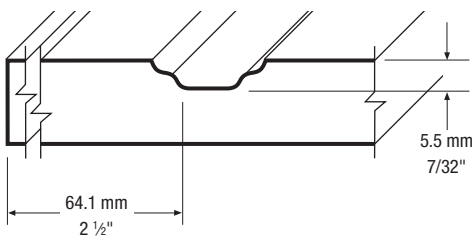

Minimum sizes

DOORS (Height x Width)

MODEL	mm	inches
132	173.7 x 173.7	6 ²⁷ / ₃₂ x 6 ²⁷ / ₃₂
232	188.7 x 173.7	7 ⁷ / ₁₆ x 6 ²⁷ / ₃₂
332	213.7 x 173.7	8 ⁷ / ₁₆ x 6 ²⁷ / ₃₂
432	$((W \div 2) + 68.8) \times 173.7$	$((W \div 2) + 2 \frac{23}{32}) \times 6 \frac{27}{32}$

DRAWER fronts (Height x Width)

MODEL	mm	inches
132	110.1 x 173.7	4 ¹¹ / ₃₂ x 6 ²⁷ / ₃₂
232	125.1 x 173.7	4 ¹⁵ / ₁₆ x 6 ²⁷ / ₃₂
332	150.1 x 173.7	5 ¹⁵ / ₁₆ x 6 ²⁷ / ₃₂
432	$((W \div 2) + 5.2) \times 173.7$	$((W \div 2) + \frac{7}{32}) \times 6 \frac{27}{32}$

W = width

Default exterior profile: C

Model **132**

Colour: R207W

SERIES 47 Category 2

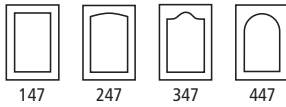
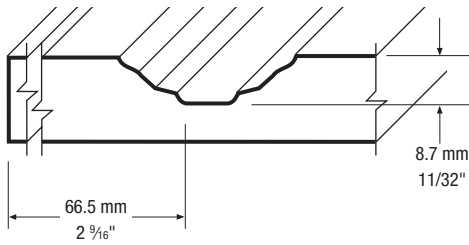

Minimum sizes

DOORS (Height x Width)

MODEL	mm	inches
147	185.5 x 185.5	7 5/16 x 7 5/16
247	200.5 x 185.5	7 29/32 x 7 5/16
347	228.5 x 210.0	9 x 8 9/32
447	((W÷2) + 69.8) x 185.5	((W÷2) + 2 3/4) x 7 5/16

DRAWER fronts (Height x Width)

MODEL	mm	inches
147	129.5 x 185.5	5 1/8 x 7 5/16
247	144.5 x 185.5	5 23/32 x 7 5/16
347	172.5 x 210.0	6 13/16 x 8 9/32
447	((W÷2) + 13.8) x 185.5	((W÷2) + 9/16) x 7 5/16

W = width
Default exterior profile: C

Model 147
Colour: A4WT

SERIES 50 Category 2

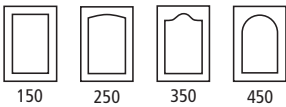
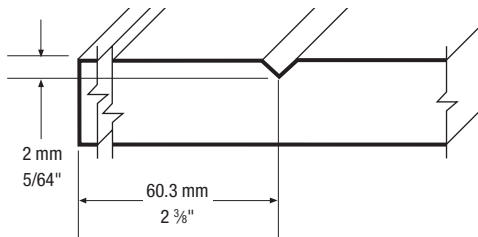

Series 50 drawer fronts come standard with full top and bottom rails. If reduced rail drawer fronts are required, it must be specified when placing your order.

Regular rail
(by default)

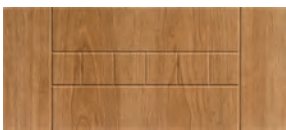

Reduced rail

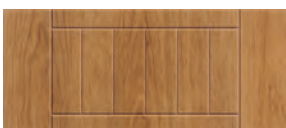

Minimum sizes

DOORS AND DRAWERS (Height x Width)

MODEL	mm	inches
150	146.0 x 146.0	5 3/4 x 5 3/4
250	161.0 x 146.0	6 11/32 x 5 3/4
350	186.0 x 200.6	7 11/32 x 7 29/32
450	((W÷2) + 60.4) x 146.0	((W÷2) + 2 13/32) x 5 3/4

REDUCED DRAWER FRONTS (Height x Width)

MODEL	mm	inches
150red	76.2 x 146.0	3 x 5 3/4
250red	91.2 x 146.0	3 19/32 x 5 3/4
350red	116.2 x 200.6	4 19/32 x 7 29/32
450red	((W÷2) - 9.4) x 146.0	((W÷2) - 3/8) x 5 3/4

NOTE: Not available with exterior profiles D, F, H, P, V and W.
red = reduced
W = width
Default exterior profile: Q

Model 150
Colour: R205W

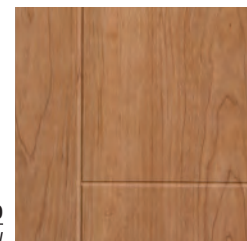

40
Category 2

Model 140
Colour: R205W

STANDARD FEATURES

- White melamine back
- Woodgrain pattern direction always runs vertically to height, unless specified otherwise
- Drawer fronts are manufactured with reduced rails unless specified
- Maximum door height: 2438 mm (96"), maximum door width: 1193 mm (47")

SERIES 06 Category 3

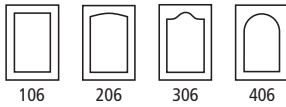
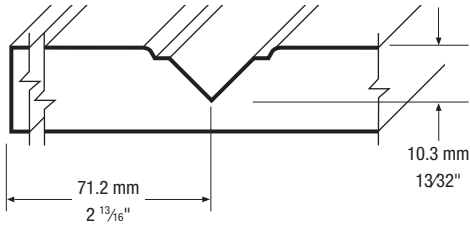

Minimum sizes

DOORS (Height x Width)

MODEL	mm	inches
106	180.2 x 180.2	7 1/8 x 7 1/8
206	195.2 x 180.2	7 11/16 x 7 1/8
306	220.2 x 180.2	8 11/16 x 7 1/8
406	$((W \div 2) + 81.5) \times 180.2$	$((W \div 2) + 3 7/32) \times 7 1/8$

DRAWER fronts (Height x Width)

MODEL	mm	inches
106	101.6 x 180.2	4 x 7 3/32
206	116.6 x 180.2	4 19/32 x 7 3/32
306	141.6 x 180.2	5 19/32 x 7 3/32
406	$((W \div 2) + 2.9) \times 180.2$	$((W \div 2) + 1/8) \times 7 3/32$

W = width

Default exterior profile: B

Model **106**

Colour: R205W

SERIES 08 Category 3

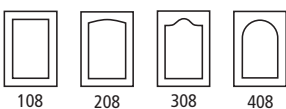
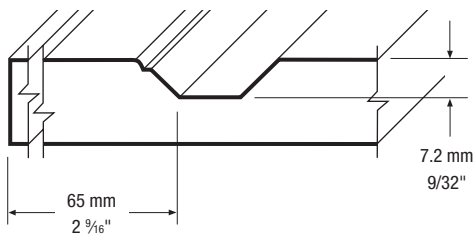

Minimum sizes

DOORS (Height x Width)

MODEL	mm	inches
108	185.1 x 185.1	7 5/16 x 7 5/16
208	200.1 x 185.1	7 29/32 x 7 5/16
308	225.1 x 185.1	8 7/8 x 7 5/16
408	$((W \div 2) + 71.8) \times 185.1$	$((W \div 2) + 2 27/32) \times 7 5/16$

DRAWER fronts (Height x Width)

MODEL	mm	inches
108	120.5 x 185.1	4 3/4 x 7 5/16
208	135.5 x 185.1	5 11/32 x 7 5/16
308	160.5 x 185.1	6 11/32 x 7 5/16
408	$((W \div 2) + 7.8) \times 185.1$	$((W \div 2) + 5/16) \times 7 5/16$

W = width

Default exterior profile: B

Model **108**

Colour: C72R

SERIES 09 Category 3

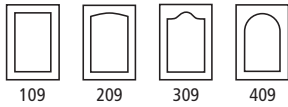
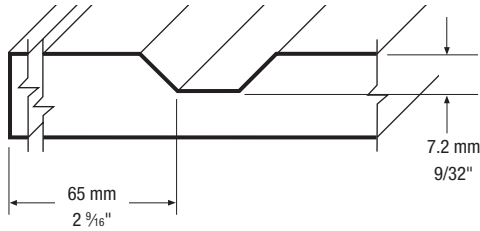

Minimum sizes

DOORS (Height x Width)

MODEL	mm	inches
109	185.1 x 185.1	7 5/16 x 7 5/16
209	200.1 x 185.1	7 29/32 x 7 5/16
309	225.1 x 185.1	8 7/8 x 7 5/16
409	$(W \div 2) + 71.8$ x 185.1	$((W \div 2) + 2 27/32) \times 7 5/16$

DRAWER fronts (Height x Width)

MODEL	mm	inches
109	121.1 x 185.1	4 25/32 x 7 5/16
209	136.1 x 185.1	5 3/8 x 7 5/16
309	161.1 x 185.1	6 11/32 x 7 5/16
409	$(W \div 2) + 7.8$ x 185.1	$((W \div 2) + 5/16) \times 7 5/16$

W = width
Default exterior profile: B

Model 109
Colour: C72R

SERIES 31 Category 3

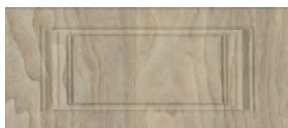
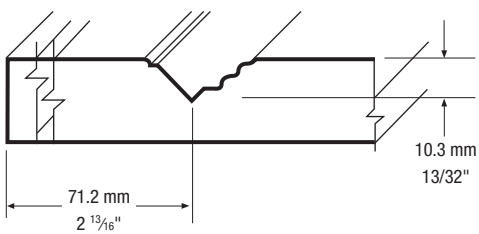

Minimum sizes

DOORS (Height x Width)

MODEL	mm	inches
131	199.4 x 199.4	7 27/32 x 7 27/32

DRAWER (Height x Width)

MODEL	mm	inches
131	120.8 x 199.4	4 3/4 x 7 27/32

Default exterior profile: O

Model 131
Colour: A15WT

STANDARD FEATURES

- White melamine back
- Woodgrain pattern direction always runs vertically to height, unless specified otherwise
- Drawer fronts are manufactured with reduced rails unless specified
- Maximum door height: 2438 mm (96"), maximum door width: 1193 mm (47")

SERIES 33 Category 3

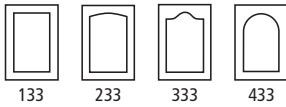
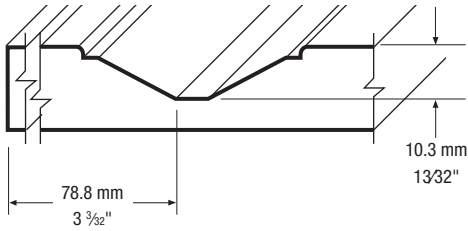

Minimum sizes

DOORS (Height x Width)

MODEL	mm	inches
133	225.0 x 225.0	8 7/8 x 8 7/8
233	240.0 x 225.0	9 15/32 x 8 7/8
333	265.0 x 225.0	10 7/16 x 8 7/8
433	$((W \div 2) + 82.5) \times 225.0$	$((W \div 2) + 3 1/4) \times 8 7/8$

DRAWER fronts (Height x Width)

MODEL	mm	inches
133	146.4 x 225.0	5 25/32 x 8 7/8
233	161.4 x 225.0	6 3/8 x 8 7/8
333	186.4 x 225.0	7 11/32 x 8 7/8
433	$((W \div 2) + 3.9) \times 225.0$	$((W \div 2) + 5/32) \times 8 7/8$

W = width

Default exterior profile: A

Model **133**

Colour: A3WT

SERIES 39 Category 3

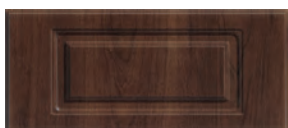
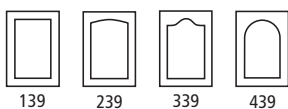
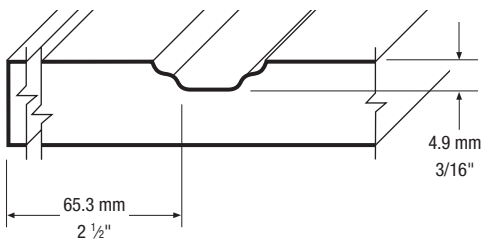

Minimum sizes

DOORS (Height x Width)

MODEL	mm	inches
139	175.7 x 175.7	6 15/16 x 6 15/16
239	190.7 x 175.7	7 17/32 x 6 15/16
339	215.7 x 200.6	8 1/2 x 7 29/32
439	$((W \div 2) + 70.0) \times 175.7$	$((W \div 2) + 2 25/32) \times 6 15/16$

DRAWER fronts (Height x Width)

MODEL	mm	inches
139	112.1 x 175.7	4 7/16 x 6 15/16
239	127.1 x 175.7	5 1/32 x 6 15/16
339	152.1 x 200.6	6 x 7 29/32
439	$((W \div 2) + 6.4) \times 175.7$	$((W \div 2) + 9/32) \times 6 15/16$

W = width

Default exterior profile: C

Model **139**

Colour: R207W

SERIES 46 Category 3

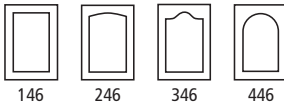
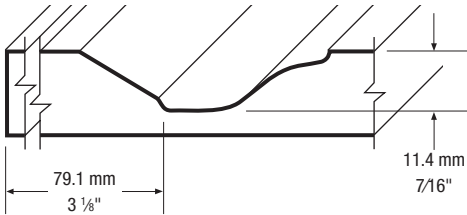

Minimum sizes

DOORS (Height x Width)

MODEL	mm	inches
146	234.4 x 234.4	9 1/4 x 9 1/4
246	254.4 x 234.4	10 1/32 x 9 1/4
346	284.4 x 234.4	11 7/32 x 9 1/4
446	$((W \div 2) + 86.5) \times 234.4$	$((W \div 2) + 3 13/32) \times 9 1/4$

DRAWER fronts (Height x Width)

MODEL	mm	inches
146	165.8 x 234.4	6 17/32 x 9 1/4
246	185.8 x 234.4	7 11/32 x 9 1/4
346	215.8 x 234.4	8 1/2 x 9 1/4
446	$((W \div 2) + 17.9) \times 234.4$	$((W \div 2) + 23/32) \times 9 1/4$

W = width
Default exterior profile: C

Model 146

Colour: C92W

SERIES 48 Category 3

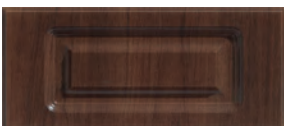
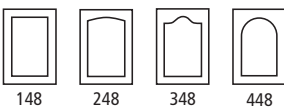
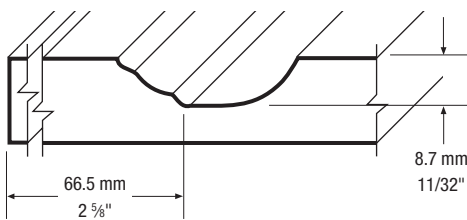

Minimum sizes

DOORS (Height x Width)

MODEL	mm	inches
148	187.8 x 187.8	7 13/16 x 7 13/32
248	202.8 x 187.8	8 x 7 13/32
348	230.8 x 210.0	9 3/32 x 8 9/32
448	$((W \div 2) + 73.1) \times 187.8$	$((W \div 2) + 2 29/32) \times 7 13/32$

DRAWER fronts (Height x Width)

MODEL	mm	inches
148	131.8 x 187.8	5 7/32 x 7 13/32
248	146.8 x 187.8	5 25/32 x 7 13/32
348	174.8 x 210.0	6 29/32 x 8 9/32
448	$((W \div 2) + 17.1) \times 187.8$	$((W \div 2) + 11/16) \times 7 13/32$

W = width
Default exterior profile: C

Model 148

Colour: R207W

STANDARD FEATURES

- White melamine back
- Woodgrain pattern direction always runs vertically to height, unless specified otherwise

- Drawer fronts are manufactured with reduced rails unless specified
- Maximum door height: 2438 mm (96"), maximum door width: 1193 mm (47")

SERIES 73 Category 3

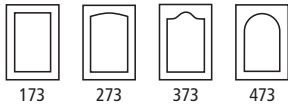
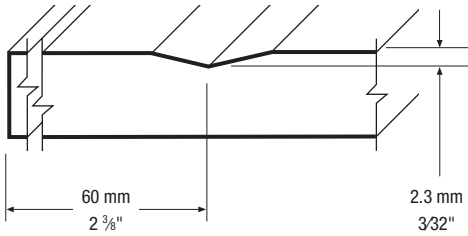

Minimum sizes

DOORS (Height x Width)

MODEL	mm	inches
173	153.7 x 153.7	6 1/16 x 6 1/16
273	168.7 x 153.7	6 21/32 x 6 1/16
373	193.7 x 200.0	7 21/32 x 7 7/8
473	$((W \div 2) + 60.1) \times 153.7$	$((W \div 2) + 2 \frac{3}{8}) \times 6 \frac{1}{16}$

DRAWER fronts (Height x Width)

MODEL	mm	inches
173	93.7 x 153.7	3 23/32 x 6 1/16
273	108.7 x 153.7	4 9/32 x 6 1/16
373	133.7 x 200.0	5 9/32 x 7 7/8
473	$((W \div 2) + 0.1) \times 153.7$	$((W \div 2) + 1/32) \times 6 \frac{1}{16}$

W = width

Default exterior profile: B

Model **173**

Colour: C92W

SERIES 912 Category 3

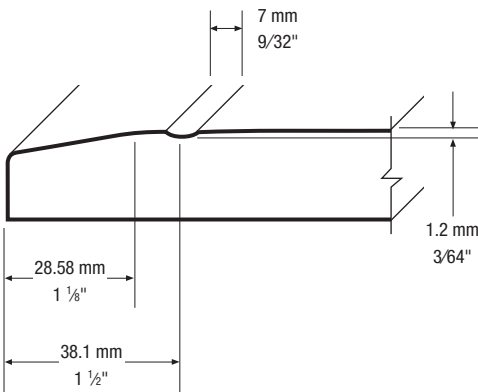

R = 3 mm



R = 3 mm

Minimum sizes

DOORS (Height x Width)

MODEL	mm	inches
912	95.9 x 95.9	3 25/32 x 3 25/32

DRAWER fronts (Height x Width)

MODEL	mm	inches
912	95.9 x 95.9	3 25/32 x 3 25/32

Default exterior profile: F

Model **912**

Colour: C92W

SERIES 03 Category 4

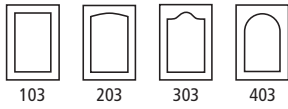
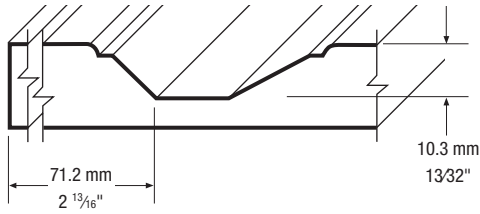

Minimum sizes

DOORS (Height x Width)

MODEL	mm	inches
103	225.0 x 225.0	8 7/8 x 8 7/8
203	240.0 x 225.0	9 15/32 x 8 7/8
303	265.0 x 225.0	10 7/16 x 8 7/8
403	$((W \div 2) + 82.5) \times 225.0$	$((W \div 2) + 3 1/4) \times 8 7/8$

DRAWER fronts (Height x Width)

MODEL	mm	inches
103	146.4 x 225.0	5 25/32 x 8 7/8
203	161.4 x 225.0	6 3/8 x 8 7/8
303	186.4 x 225.0	7 11/32 x 8 7/8
403	$((W \div 2) + 3.9) \times 225.0$	$((W \div 2) + 5/32) \times 8 7/8$

W = width
Default exterior profile: B

Model 103

Colour: A15WT

SERIES 27 Category 4

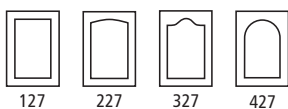
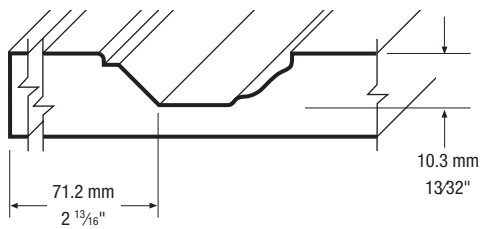

Minimum sizes

DOORS (Height x Width)

MODEL	mm	inches
127	208.4 x 208.4	8 7/32 x 8 7/32
227	223.4 x 208.4	8 13/16 x 8 7/32
327	248.4 x 208.4	9 25/32 x 8 7/32
427	$((W \div 2) + 81.2) \times 208.4$	$((W \div 2) + 3 7/32) \times 8 7/32$

DRAWER fronts (Height x Width)

MODEL	mm	inches
127	129.8 x 208.4	5 1/8 x 8 7/32
227	144.8 x 208.4	5 23/32 x 8 7/32
327	169.8 x 208.4	6 11/16 x 8 7/32
427	$((W \div 2) + 2.6) \times 208.4$	$((W \div 2) + 1/8) \times 8 7/32$

W = width
Default exterior profile: A

Model 127

Colour: R205W

STANDARD FEATURES

- White melamine back
- Woodgrain pattern direction always runs vertically to height, unless specified otherwise

- Drawer fronts are manufactured with reduced rails unless specified
- Maximum door height: 2438 mm (96"), maximum door width: 1193 mm (47")

SERIES 49 Category 4

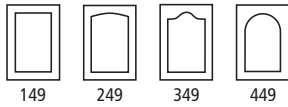
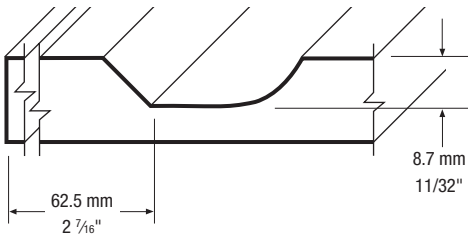

Minimum sizes

DOORS (Height x Width)

MODEL	mm	inches
149	195.6 x 195.6	7 ²³ / ₃₂ x 7 ²³ / ₃₂
249	210.6 x 195.6	8 ⁵ / ₁₆ x 7 ²³ / ₃₂
349	238.6 x 220.0	9 ¹³ / ₃₂ x 8 ¹¹ / ₁₆
449	$((W \div 2) + 77) \times 195.6$	$((W \div 2) + 3 \frac{1}{16}) \times 7 \frac{23}{32}$

DRAWER fronts (Height x Width)

MODEL	mm	inches
149	139.6 x 195.6	5 ¹ / ₂ x 7 ²³ / ₃₂
249	154.6 x 195.6	6 ³ / ₃₂ x 7 ²³ / ₃₂
349	185.6 x 220.0	7 ⁵ / ₁₆ x 8 ¹¹ / ₁₆
449	$((W \div 2) + 21) \times 195.6$	$((W \div 2) + \frac{27}{32}) \times 7 \frac{23}{32}$

W = width

Default exterior profile: C

Model **149**

Colour: R205W

SERIES 76 Category 4

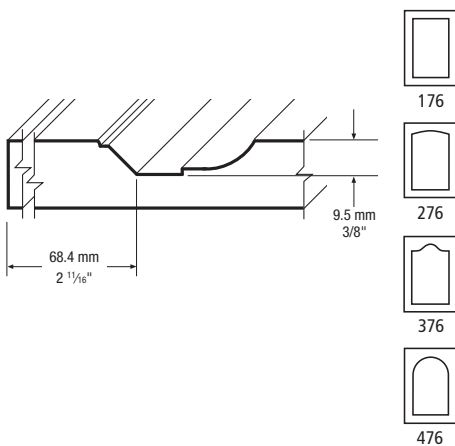

Reduced rail



Minimum sizes

DOORS AND DRAWERS (Height x Width)

MODEL	mm	inches
176	216.1 x 216.1	8 ¹⁷ / ₃₂ x 8 ¹⁷ / ₃₂
276	231.1 x 216.1	9 ¹ / ₈ x 8 ¹⁷ / ₃₂
376	256.1 x 216.1	10 ³ / ₃₂ x 8 ¹⁷ / ₃₂
476	$((W \div 2) + 87.7) \times 216.1$	$((W \div 2) + 3 \frac{15}{32}) \times 8 \frac{17}{32}$

DRAWER FRONTS with reduced rails (Height x Width)

MODEL	mm	inches
176	149.2 x 216.1	5 ⁷ / ₈ x 8 ¹⁷ / ₃₂
276	164.2 x 216.1	6 ¹⁵ / ₃₂ x 8 ¹⁷ / ₃₂
376	189.2 x 216.1	7 ¹⁵ / ₃₂ x 8 ¹⁷ / ₃₂
476	$((W \div 2) + 20.9) \times 216.1$	$((W \div 2) + \frac{27}{32}) \times 8 \frac{17}{32}$

W = width

Default exterior profile: B

Model **176**

Colour: R207W

SERIES 07 Category 5

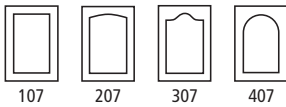
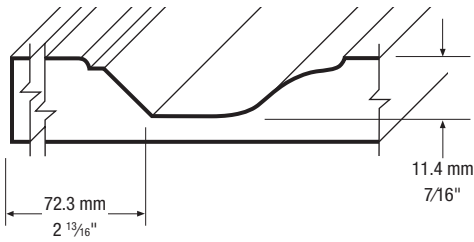

Minimum sizes

DOORS (Height x Width)

MODEL	mm	inches
107	235.0 x 235.0	9 9/32 x 9 9/32
207	250.0 x 235.0	9 27/32 x 9 9/32
307	275.0 x 235.0	10 27/32 x 9 9/32
407	((W÷2) + 86.8) x 235.0	((W÷2) + 3 7/16) x 9 9/32

DRAWER fronts (Height x Width)

MODEL	mm	inches
107	156.4 x 235.0	6 3/16 x 9 9/32
207	171.4 x 235.0	6 3/4 x 9 9/32
307	196.4 x 235.0	7 3/4 x 9 9/32
407	((W÷2) + 8.2) x 235.0	((W÷2) + 1 11/32) x 9 9/32

W = width
Default exterior profile: B

Model 107
Colour: F435WT

SERIES 83 Category 6

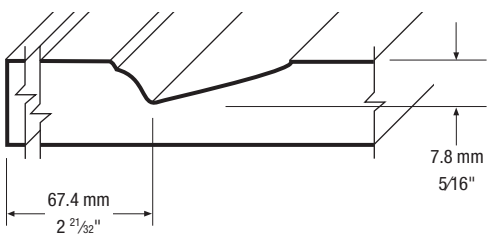

Model 183, a "true square corner" door (chiselled corners). Model 193, same interior profile as model 183 except the inside bead has a slight radius (not a "true square corner" door).

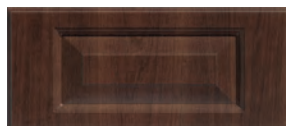
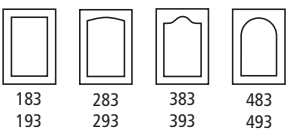

Minimum sizes

DOORS (Height x Width)

MODEL	mm	inches
183 / 193	201.5 x 201.5	7 15/16 x 7 15/16
283 / 293	216.5 x 201.5	8 17/32 x 7 15/16
383 / 393	241.5 x 230.8	9 17/32 x 9 3/32
483 / 493	((W÷2) + 112.5) x 201.5	((W÷2) + 4 7/16) x 7 15/16

DRAWER fronts (Height x Width)

MODEL	mm	inches
183 / 193	138.3 x 201.5	5 15/32 x 7 15/16
283 / 293	153.3 x 201.5	6 1/16 x 7 15/16
383 / 393	178.3 x 230.8	7 1/32 x 9 3/32
483 / 493	((W÷2) + 49.3) x 201.5	((W÷2) + 1 31/32) x 7 15/16

W = width
Default exterior profile: C

Model 183
Colour: R207W

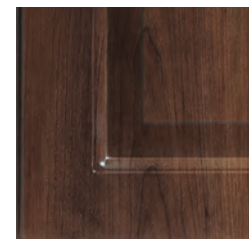

93
Category 5

Model 193
Colour: R207W

STANDARD FEATURES

- White melamine back
- Woodgrain pattern direction always runs vertically to height, unless specified otherwise

- Drawer fronts are manufactured with reduced rails unless specified
- Maximum door height: 2438 mm (96"), maximum door width: 1193 mm (47")

SERIES 85 Category 6

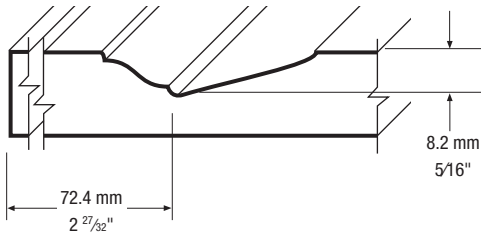

Model 185, a "true square corner" door (chiselled corners). Model 195, same interior profile as model 185 except the inside bead has a slight radius (not a "true square corner" door).

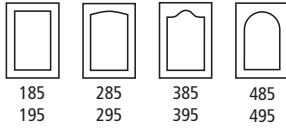

Model **185**
Colour: C92W



Minimum sizes

DOORS (Height x Width)

MODEL	mm	inches
185 / 195	212.4 x 212.4	8 3/8 x 8 3/8
285 / 295	227.4 x 212.4	8 31/32 x 8 3/8
385 / 395	252.4 x 250.8	9 15/16 x 9 7/8
485 / 495	$(W \div 2) + 117.5$ x 212.4	$((W \div 2) + 4 21/32)$ x 8 3/8

DRAWER fronts (Height x Width)

MODEL	mm	inches
185 / 195	149.2 x 212.4	5 7/8 x 8 3/8
285 / 295	164.2 x 212.4	6 15/32 x 8 3/8
385 / 395	189.2 x 250.8	7 15/32 x 9 7/8
485 / 495	$(W \div 2) + 54.3$ x 212.4	$((W \div 2) + 2 5/32)$ x 8 3/8

W = width

Default exterior profile: C



95
Category 5

Model **195**
Colour: C92W

SERIES 86 Category 6

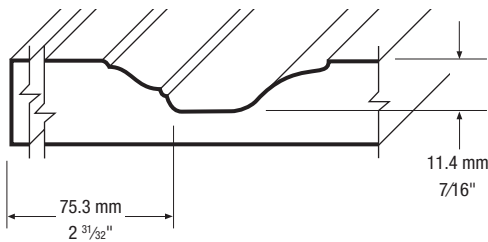

Model 186, a "true square corner" door (chiselled corners). Model 196, same interior profile as model 186 except the inside bead has a slight radius (not a "true square corner" door).

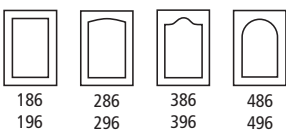

Model **186**
Colour: C92W



Minimum sizes

DOORS (Height x Width)

MODEL	mm	inches
186 / 196	237.4 x 237.4	9 3/8 x 9 3/8
286 / 296	252.4 x 237.4	9 15/16 x 9 3/8
386 / 396	277.4 x 250.8	10 15/16 x 9 7/8
486 / 496	$(W \div 2) + 117.5$ x 237.4	$((W \div 2) + 4 21/32)$ x 9 3/8

DRAWER fronts (Height x Width)

MODEL	mm	inches
186 / 196	174.2 x 237.4	6 7/8 x 9 3/8
286 / 296	189.2 x 237.4	7 15/32 x 9 3/8
386 / 396	214.2 x 250.8	8 7/16 x 9 7/8
486 / 496	$(W \div 2) + 54.3$ x 237.4	$((W \div 2) + 2 5/32)$ x 9 3/8

W = width

Default exterior profile: C



96
Category 5

Model **196**
Colour: C92W

SERIES 87 Category 6

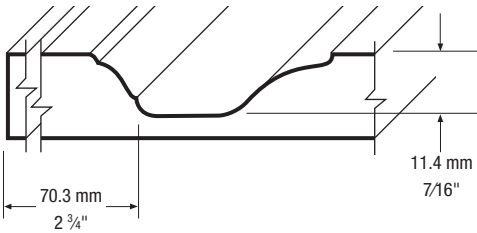

Model 187, a "true square corner" door (chiselled corners).
Model 197, same interior profile as model 187 except the inside bead has a slight radius (not a "true square corner" door).

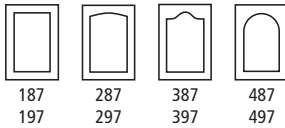

Model **187**
Colour: A4WT



Minimum sizes

DOORS (Height x Width)

MODEL	mm	inches
187 / 197	227.4 x 227.4	8 ³¹ / ₃₂ x 8 ³¹ / ₃₂
287 / 297	242.4 x 227.4	9 ⁹ / ₁₆ x 8 ³¹ / ₃₂
387 / 397	267.4 x 230.8	10 ¹⁷ / ₃₂ x 9 ³ / ₈
487 / 497	$((W \div 2) + 112.5) \times 227.4$	$((W \div 2) + 4 \frac{7}{16}) \times 8 \frac{31}{32}$

DRAWER fronts (Height x Width)

MODEL	mm	inches
187 / 197	164.2 x 227.4	6 ¹⁵ / ₃₂ x 8 ³¹ / ₃₂
287 / 297	179.2 x 227.4	7 ¹ / ₁₆ x 8 ³¹ / ₃₂
387 / 397	204.2 x 230.8	8 ¹ / ₁₆ x 9 ³ / ₈
487 / 497	$((W \div 2) + 49.3) \times 227.4$	$((W \div 2) + 1 \frac{31}{32}) \times 8 \frac{31}{32}$

W = width

Default exterior profile: C



97
Category 5

Model **197**
Colour: A4WT

SERIES 88 Category 6

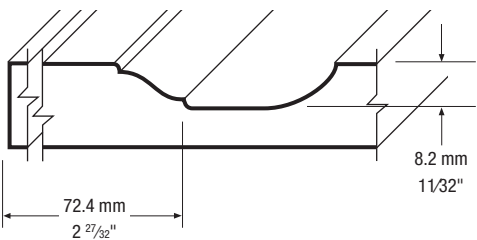

Model 188, a "true square corner" door (chiselled corners).
Model 198, same interior profile as model 188 except the inside bead has a slight radius (not a "true square corner" door).

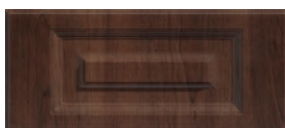
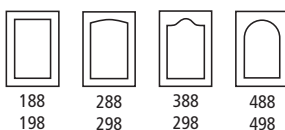

Model **188**
Colour: R207W



Minimum sizes

DOORS (Height x Width)

MODEL	mm	inches
188 / 198	214.9 x 214.9	8 ¹⁵ / ₃₂ x 8 ¹⁵ / ₃₂
288 / 298	229.9 x 214.9	9 ¹ / ₁₆ x 8 ¹⁵ / ₃₂
388 / 398	254.9 x 250.8	10 ¹ / ₁₆ x 9 ⁷ / ₈
488 / 498	$((W \div 2) + 117.5) \times 214.9$	$((W \div 2) + 4 \frac{21}{32}) \times 8 \frac{15}{32}$

DRAWER fronts (Height x Width)

MODEL	mm	inches
188 / 198	151.7 x 214.9	6 x 8 ¹⁵ / ₃₂
288 / 298	166.7 x 214.9	6 ⁹ / ₁₆ x 8 ¹⁵ / ₃₂
388 / 398	191.7 x 250.8	7 ⁹ / ₁₆ x 9 ⁷ / ₈
488 / 498	$((W \div 2) + 54.3) \times 214.9$	$((W \div 2) + 2 \frac{5}{32}) \times 8 \frac{15}{32}$

W = width

Default exterior profile: C



98
Category 5

Model **198**
Colour: R207W

STANDARD FEATURES

- White melamine back
- Woodgrain pattern direction always runs vertically to height, unless specified otherwise
- Drawer fronts are manufactured with reduced rails unless specified
- Maximum door height: 2438 mm (96"), maximum door width: 1193 mm (47")

SERIES 89 Category 6

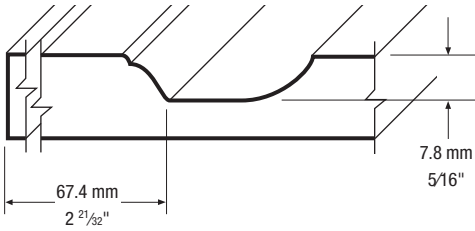

Model 189, a "true square corner" door (chiselled corners).
 Model 199, same interior profile as model 189 except the inside bead has a slight radius (not a "true square corner" door).

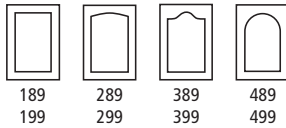

189 289 389 489
 199 299 399 499



Model **189**
 Colour: R205W



Minimum sizes

DOORS (Height x Width)

MODEL	mm	inches
189 / 199	204.4 x 204.4	8 1/16 x 8 1/16
289 / 299	219.4 x 204.4	8 21/32 x 8 1/16
389 / 399	244.4 x 230.8	9 5/8 x 9 3/16
489 / 499	$(W \div 2) + 112.5$ x 204.4	$((W \div 2) + 4 7/16)$ x 8 1/16

DRAWER fronts (Height x Width)

MODEL	mm	inches
189 / 199	141.2 x 204.4	5 9/16 x 8 1/16
289 / 299	156.2 x 204.4	6 5/32 x 8 1/16
389 / 399	181.2 x 230.8	7 5/32 x 9 3/16
489 / 499	$(W \div 2) + 49.3$ x 204.4	$((W \div 2) + 1 31/32)$ x 8 1/16

W = width
 Default exterior profile: C



99

Category 5

Model **199**
 Colour: R205W



A661S - Moon Light - Satin

SERIES 943 Premium

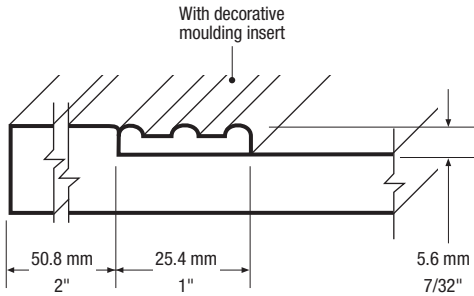

Minimum sizes

DOORS (Height x Width)

MODEL	mm	inches
943	176.2 x 176.2	6 ¹⁵ / ₁₆ x 6 ¹⁵ / ₁₆

DRAWER fronts (Height x Width)

MODEL	mm	inches
943	126.2 x 176.2	4 ³¹ / ₃₂ x 6 ¹⁵ / ₁₆

Default exterior profile: C

Model **943**

Colour: F434WT

SERIES 944 Premium

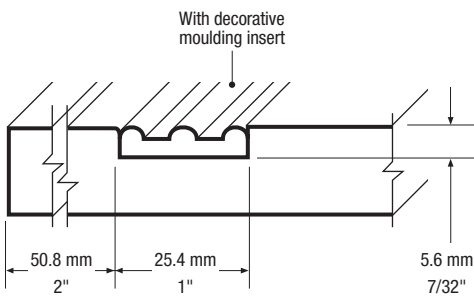

Minimum sizes

DOORS (Height x Width)

MODEL	mm	inches
944	176.2 x 176.2	6 ¹⁵ / ₁₆ x 6 ¹⁵ / ₁₆

DRAWER fronts (Height x Width)

MODEL	mm	inches
944	126.2 x 176.2	4 ³¹ / ₃₂ x 6 ¹⁵ / ₁₆

Default exterior profile: C

Model **944**

Colour: A3WT

STANDARD FEATURES

- White melamine back
- Woodgrain pattern direction always runs vertically to height, unless specified otherwise
- Drawer fronts are manufactured with reduced rails unless specified
- Maximum door height: 2438 mm (96"), maximum door width: 1193 mm (47")

SERIES 928 Premium

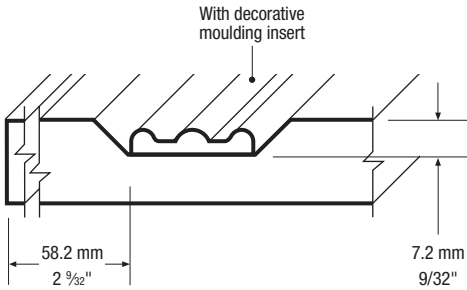

Minimum sizes

DOORS (Height x Width)

MODEL	mm	inches
928	96.0 x 196.0	7 ²³ / ₃₂ x 7 ²³ / ₃₂

DRAWER fronts (Height x Width)

MODEL	mm	inches
928	146.0 x 196.0	5 ³ / ₄ x 7 ²³ / ₃₂

NOTE: No groove for retainer on mullion door.
Default exterior profile: C

Model 928

Colour: R205W



SERIES 911 Category 3

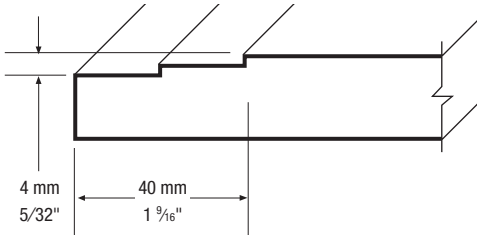

Minimum sizes

DOORS (Height x Width)

MODEL	mm	inches
911	92.7 x 92.7	3 21/32 x 3 21/32

DRAWER fronts (Height x Width)

MODEL	mm	inches
911	92.7 x 92.7	3 21/32 x 3 21/32

Default exterior profile: door model 911 manufactured with its own exterior profile.

Model 911

Colour: C92W

SERIES 921 Category 3

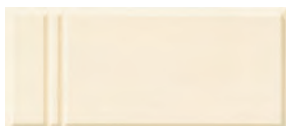
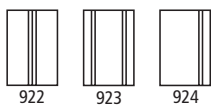
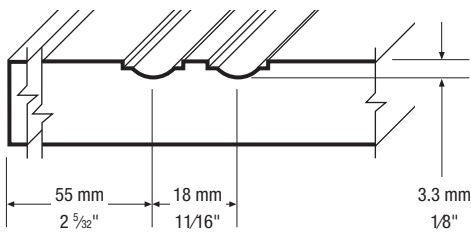

Minimum sizes

DOORS (Height x Width)

MODEL	mm	inches
921	38.1 x 128.0	1 1/2 x 5 1/16
922	38.1 x 128.0	1 1/2 x 5 1/16
923	38.1 x 171.4	1 1/2 x 6 3/4
924	38.1 x 128.0	1 1/2 x 5 1/16

DRAWER fronts (Height x Width)

MODEL	mm	inches
921	38.1 x 128.0	1 1/2 x 5 1/16
922	38.1 x 128.0	1 1/2 x 5 1/16
923	38.1 x 171.4	1 1/2 x 6 3/4
924	38.1 x 128.0	1 1/2 x 5 1/16

Default exterior profile: door models 921 to 924 are manufactured with its own exterior profile.

Model 921

Colour: C72R

STANDARD FEATURES

- White melamine back
- Woodgrain pattern direction always runs vertically to height, unless specified otherwise
- Drawer fronts are manufactured with reduced rails unless specified
- Maximum door height: 2438 mm (96"), maximum door width: 1193 mm (47")

SERIES 972 Category 4

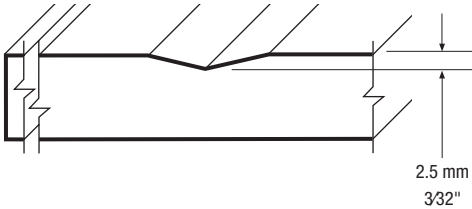

Model **972**
Colour: C92W



Model **975**
Colour: C92W



Minimum sizes

DOORS (Height x Width)

MODEL	mm	inches
972	264.2 x 213.7	10 ¹³ / ₃₂ x 8 ⁷ / ₁₆

DRAWER fronts (Height x Width)

MODEL	mm	inches
972	144.2 x 213.7	5 ¹¹ / ₁₆ x 8 ⁷ / ₁₆
975	144.2 x 273.1	5 ¹¹ / ₁₆ x 10 ³ / ₄

Default exterior profile: B

Model **972**
Colour: C92W

SERIES 974 Category 4

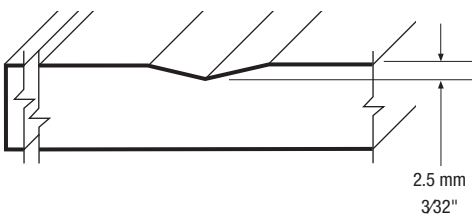

Minimum sizes

DOORS (Height x Width)

MODEL	mm	inches
974	213.7 x 213.7	8 ⁷ / ₁₆ x 8 ⁷ / ₁₆

DRAWER fronts (Height x Width)

MODEL	mm	inches
974	164.2 x 213.7	6 ¹⁵ / ₃₂ x 8 ⁷ / ₁₆

Default exterior profile: B

Model **974**
Colour: C72R

SERIES 996 Category 3



Model **996**
Colour: A24WT

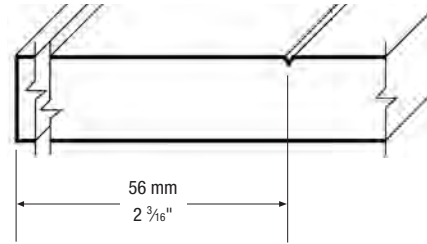

**VERTICAL
CROSS SECTION**

**HORIZONTAL
CROSS SECTION**

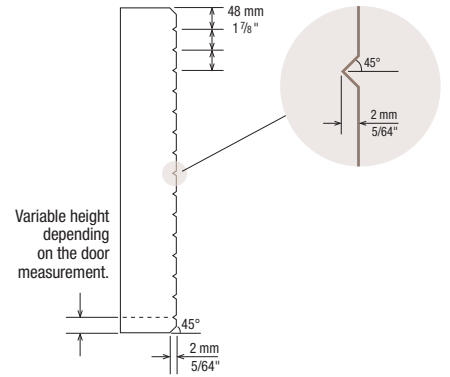

**ALIGNMENT OF ADJACENT DOORS
AND DRAWERS**

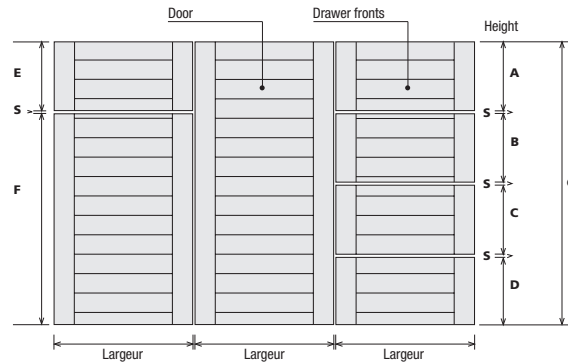

A, B, C, D, E, F and G: height of doors and drawers.
S: vertical space required between drawers.

FRAME DOORS

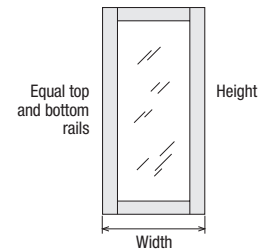

Minimum sizes

DOORS (Height x Width)

MODEL	mm	inches
996	38.1 x 162.8	1 1/2 x 6 7/16

Note: Not available with exterior profiles D, F, H and P.
Default exterior profile: Y

SERIES 910 Category 6



Model **910**
Colour: F44W

**VERTICAL
CROSS SECTION**

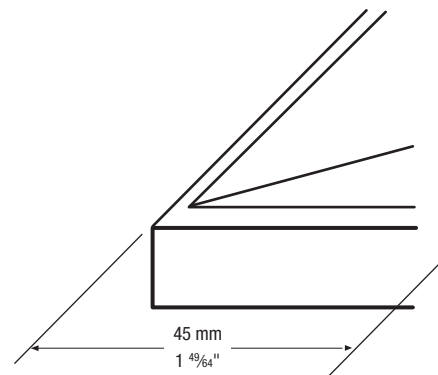
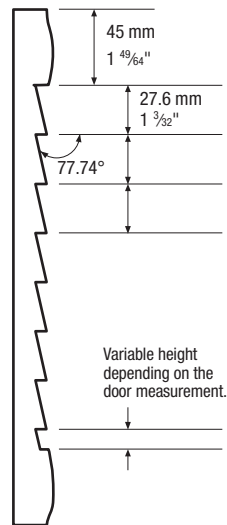

Minimum sizes

DOORS (Height x Width)

MODEL	mm	inches
910	147.0 x 254.0	5 13/16 x 10

NOTE: Default exterior profile: Q

PANELS

MULTIPLE PANELS | APPLIANCE PANELS
BUILT-IN APPLIANCE PANELS | WINE RACKS

Multiple Panels



Model 5282
Double
Colour: R205W

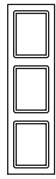

Model 5283
Triple

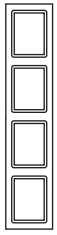

Model 5284
Quadruple

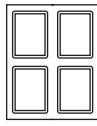

Model 5288
Quadruple

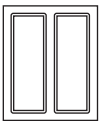

Model 5285
Split

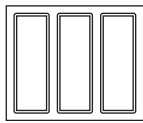

Model 5286
Triple Split

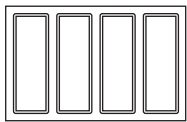

Model 5287
Quadruple Split

OPTION

Multiple and Appliance Panels may be separated by profiles matching edge details to appear as individual door sections. If individual door section sizes are not specified, they will be produced in equal sizes.

Appliance Panels

Appliance panels are available in the same models as the doors and multiple panels. However, their exterior is modified, as shown, to simplify their insertion.

Exterior profile **C** in this example.
Available profiles: **A, B, C, F, I, J, L, Y.**

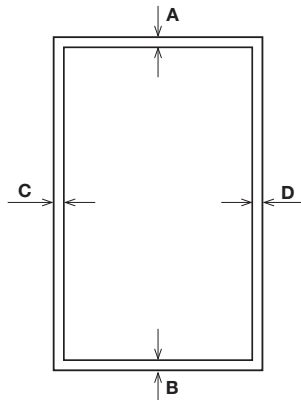
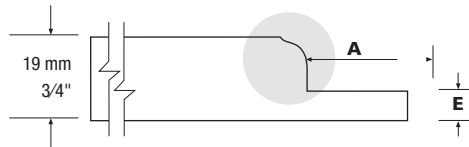

SPECIFICATIONS

Values from **A** to **E** must be specified. If not specified, default value for **E** will be 6.35 mm (1/4"). Minimum size for **E** is 4.76 mm (3/16").

MODELS AVAILABLE

- Simple (5270)
- Double (5272)
- Double Split (5275)
- Triple (5273)
- Triple Split (5276)
- Quadruple (5274, 5278)
- Quadruple Split (5287)

Built-in Appliance/Panels



Model 5566
Colour: R205W

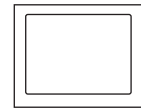

Model 5560

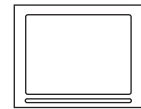

Model 5561

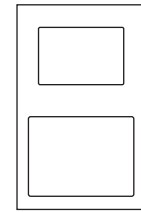

Model 5567

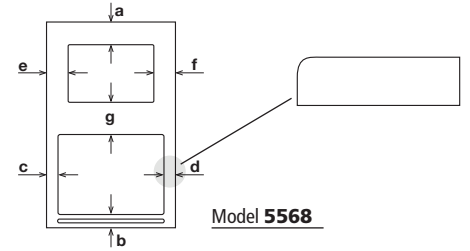

Model 5568

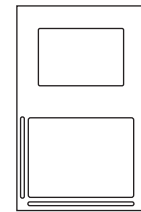

Model 5569

SPECIFICATIONS

- 1) All profiles available for both the inside edge detail and exterior profile. Profiles by default are **J** for the inside edge detail and **Q** for the exterior profile.
- 2) All vents centred horizontally and vertically.
- 3) Rail width minimum sizes:
 - with vent, 50 mm (2");
 - without vent, 38.1 mm (1 1/2")
- 4) For models 5567, 5568 and 5569, please specify at least 1 opening height.

STANDARD CONFIGURATION

Special programming will apply for non standard configurations.

Wine Racks

CIRCLE SHAPED



Model **5132**
Colour: F435WT



Model **5133**
Colour: F435WT

SPECIFICATIONS

- If models 5132 and 5133 are paired together, it must be specified when placing your order.
- Minimum size:
 - 5132: 76.2 mm (3") height
 - 5133: 69.8 mm (2 3/4") height



Model **5134**
Colour: F435WT



Model **5138**
Colour: F435WT

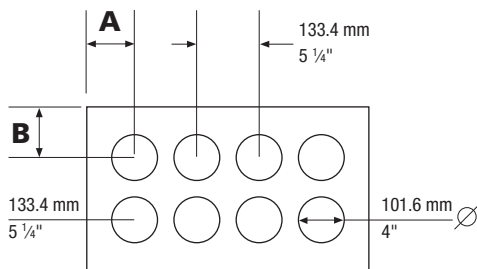

SPECIFICATIONS

- 1) Standard Hole Diameter: 101.6 mm (4")
- 2) Distance between holes: 133.4 mm (5 1/4")
- 3) $A = \frac{[Width - (number\ of\ holes - 1) \times 133.4\ mm]}{2}$
 $\frac{[Width - (number\ of\ hole - 1) \times 5\ 1/4"]}{2}$
- 4) $B = \frac{[Height - (number\ of\ hole - 1) \times 133.4\ mm]}{2}$
 $\frac{[Height - (number\ of\ hole - 1) \times 5\ 1/4"]}{2}$
- 4) **A** or **B** minimum size: 76.2 mm (3")

X SHAPED



Model **5141**
Colour: R205W



Model **5142**
Colour: R205W



Model **5143**
Colour: R205W

SPECIFICATIONS

Opening size: 101.6 x 101.6 mm (4" x 4")

NOTE: Number of openings varies according to specified dimensions.

PRODUCT	HOLE NUMBER	MINIMUM SIZE		MAXIMUM SIZE	
		mm	po.	mm	po.
5134/5138	1	152.4	6	285.7	11 1/4
	2	285.8	11 1/4	419.0	16 1/2
	3	419.1	16 1/2	552.4	21 3/4
	4	552.5	21 3/4	685.7	27
	5	685.8	27	819.1	32 1/4
	6	819.2	32 1/4	952.4	37 1/2
5141/5142	1	239.4	9 3/8	427.9	16 7/8
	2	428.0	16 7/8	616.5	24 1/4
	3	616.6	24 1/4	805.0	31 3/4
	4	805.1	31 3/4	993.6	39 1/8
	5	993.7	39 1/8	1182.2	46 1/2
	6	1182.3	46 1/2	1370.8	54
5143	1	194.5	7 5/8	383.0	15 1/8
	2	383.1	15 1/8	571.6	22 1/2
	3	571.7	22 1/2	760.1	29 7/8
	4	760.2	29 7/8	948.7	37 3/8
	5	948.8	37 3/8	1137.3	44 3/4
	6	1137.4	44 3/4	1325.9	52 1/4



Model **4101**
Colour: R205W



Model **4106**
Colour: R205W

Standards

SERIE 4100

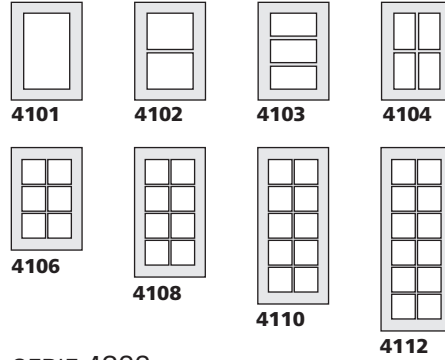

SERIE 4300

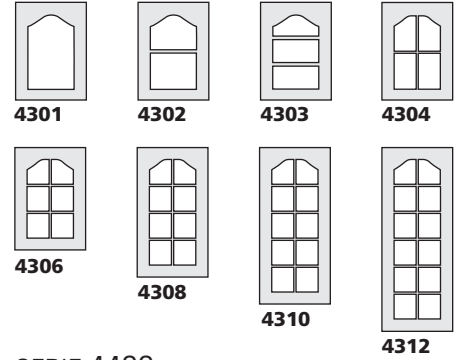

SERIE 4200

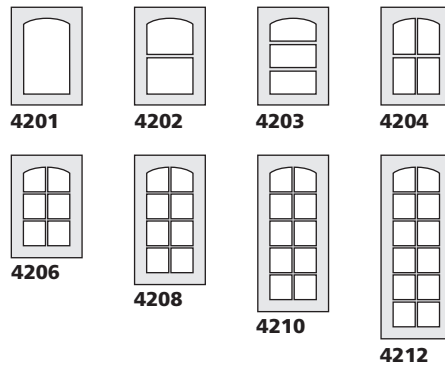

SERIE 4400

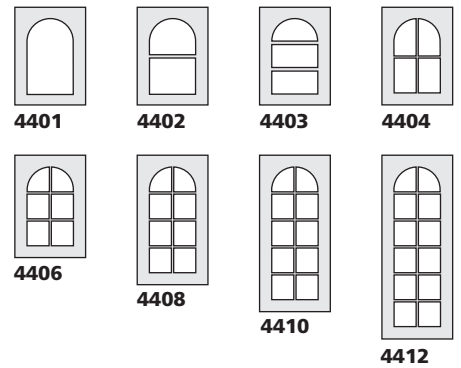

Special

SERIE 6300-6400

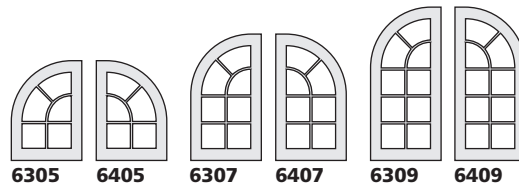

SERIE 6700

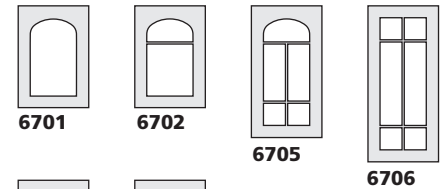

SERIE 6500-6600

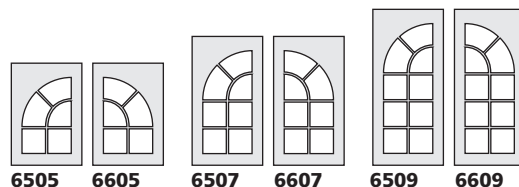
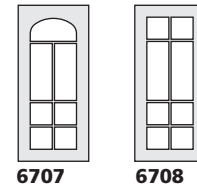
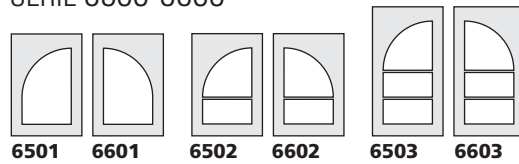

SERIE 6900

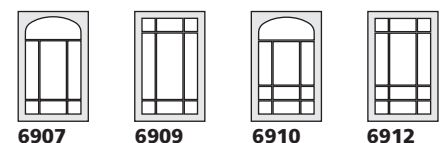

SPECIFICATIONS

An interior profile must be specified for model 000 frame or mullion door.

NOTE: Models 911 and 912 frame or mullion door are manufactured with 09 interior profile.

OPTION

MDF core will be visible on the back of the frame and mullion doors.
Painting of exposed surfaces is available as an option.

SPECIFICATIONS

- 1) For special mullion frames (except series 6900) where the mullion bars line-up horizontally, the door widths must be identical.
- 2) An interior profile must be specified for models 000, 911, 912 (profile 09 by default) and 910 (profile 151 by default) frame or mullion doors.
- 3) Series 83 to 89 are only available in special mullion door models 6706, 6708, 6909 and 6912. This restriction does not apply to series 93 to 99.
- 4) Models 928, 942, 943 and 944 are available only in 4100 series.
- 5) Model 996 frame and mullion doors are available only in 4100 series.
- 6) Mitre style models 7730-31-32, 7740-41-42, 7930-31-32, 7940-41-42 and 928 are not available with glass retainer insert grooves.

Glass insert sizes

MODEL	Height		Width	
	mm	inches	mm	inches
01-03-04-06-07-27-31-33-46-71-73-774X*-974	H - 115	H - 4 1/2	W - 115	W - 4 1/2
08-09-32-39-47-48-49-50-51-52-55-56-58-70-72-74-75-76-77-78-83-85-86-87-88-89-93-95-96-97-98-99-167-767-942-972	H - 102	H - 4	W - 102	W - 4
15-42	H - 91	H - 3 9/16	W - 91	W - 3 9/16
928*	H - 147	H - 5 13/16	W - 147	W - 5 13/16
921-922-924	H - 91	H - 3 9/16	W - 127	W - 5
923	H - 91	H - 3 9/16	W - 163	W - 6 7/16
996	H - 88	H - 3 1/2	W - 102	W - 4
943-944	H - 131	H - 5 5/32	W - 131	W - 5 5/32
773X*-793X*	H - 96	H - 3 13/16	W - 96	W - 3 13/16
794X*	H - 109	H - 4 5/16	W - 109	W - 4 5/16
41-61-62-65-66-164-764	H - 127	H - 5	W - 127	W - 5

H = height W = width

* No groove for retainer

Glass Retainer Moulding

COLOURS AVAILABLE

- Clear (5351)
- White (5350)

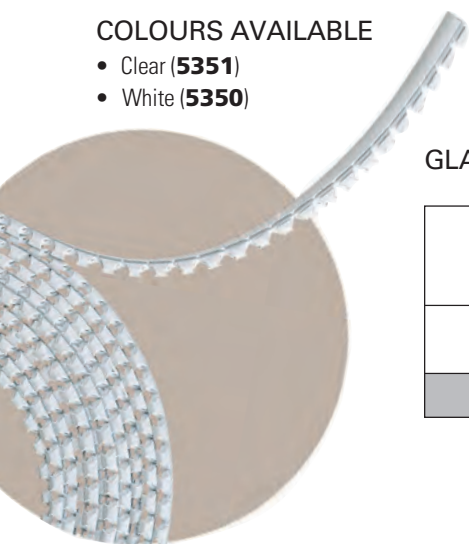

GLASS INSTALLATION

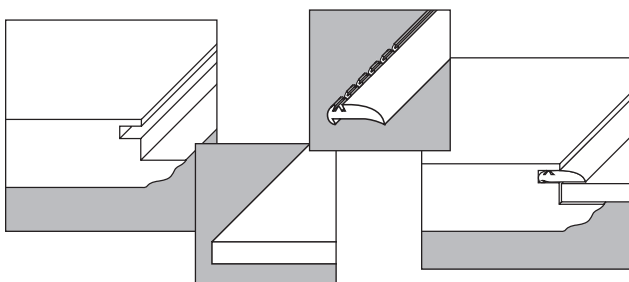

SPECIFICATIONS

Suggested glass thickness: 3 mm (1/8") to 5 mm (3/16"). For dimensions over 48", glass thickness of 5 mm (3/16") suggested.

Minimum sizes

MODELS 4100 - 4200 - 4300		
Lites	Height x Width	
	mm	inches
01	203.2 x 203.2	8 x 8
02	279.4 x 203.2	11 x 8
03	368.3 x 203.2	14 1/2 x 8
04	279.4 x 279.4	11 x 11
06	368.3 x 279.4	14 1/2 x 11
08	457.2 x 279.4	18 x 11
10	546.1 x 279.4	21 1/2 x 11
12	635.0 x 279.4	25 x 11

MODEL 4400	
Lites	Height x Width
01	*
02	≥ W
03	≥ 1.4 x W
04	≥ W
06	≥ 1.4 x W
08	≥ 1.8 x W
10	≥ 2.2 x W
12	≥ 2.6 x W

* Mullion frames 4401 have the same minimum sizes as their corresponding door model (ex.: 401, etc.).

MODELS 6300 - 6400 - 6500 - 6600	
Series	Height
6305 - 6405	≥ 1.4 x W
6307 - 6407	≥ 1.6 x W
6309 - 6409	≥ 2 x W
6501 - 6601	≥ W
6502 - 6602	≥ 1.4 x W
6503 - 6603	≥ 1.6 x W
6505 - 6605	≥ 1.4 x W
6507 - 6607	≥ 1.6 x W
6509 - 6609	≥ 2.0 x W

The radius of the arch is not equal to the width of the door. Please contact a Customer Service Representative for more information.

MODEL 6700	
Series	Height
6701	≥ 0.6 x W
6702	≥ 0.9 x W
6705	≥ 1.5 x W
6706	≥ 1.5 x W
6707	≥ 1.9 x W
6708	≥ 1.9 x W

MODEL 6900		
Series	Height x Width	
6907	500 x 444.5	19 11/16 x 17 1/2
6909	425 x 444.5	16 3/4 x 17 1/2
6910	600 x 444.5	23 5/8 x 17 1/2
6912	525 x 444.5	20 11/16 x 17 1/2

Decorative Mouldings

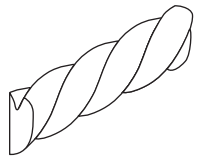

Model **5902**

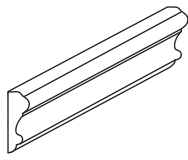

Model **5903**

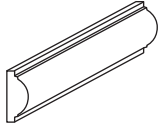

Model **5908**

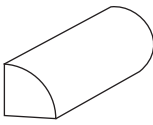

Model **5909**

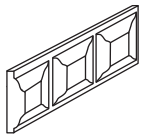

Model **5912**

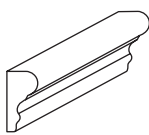

Model **5914**

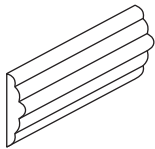

Model **5918**

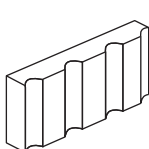

Model **5942**

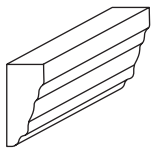

Model **5960**

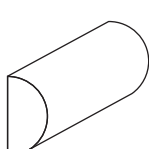

Model **5992**

Height x Thickness

MODEL	mm	inches
5767	40.6 x 15.2	1 5/8 x 5/8
5902	17.5 x 7	1 1/16 x 9/32
5903	20.6 x 6.4	1 3/16 x 1/4
5908	19 x 8	3/4 x 5/16
5909	19 x 19	3/4 x 3/4
5912	22.2 x 8	7/8 x 5/16
5914	25.4 x 12	1 x 1 5/32
5918	27 x 6.4	1 1/16 x 1/4
5942	25.4 x 19	1 x 3/4
5960	35 x 16	1 3/8 x 5/8
5992	38 x 19	1 1/2 x 3/4

SPECIFICATIONS

- 2.4 m (8') lengths.
- Definition will vary according the thickness of the foil.
- Models 5902, 5912: 94" length

Decorative moulding

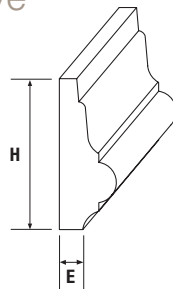

Model **5767**

Trim Moulding

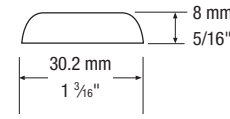

Model **747**

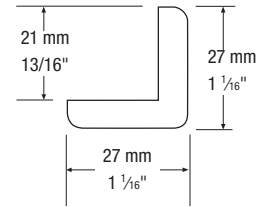
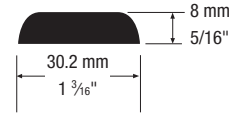

Model **748**

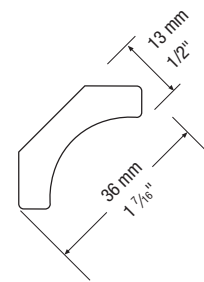
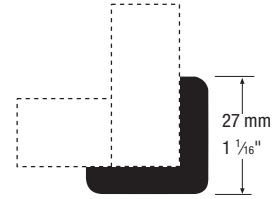

Model **758**

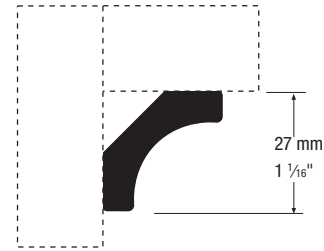

BULK PACKAGING

MODEL	PIECES/BOX
747-748-758	24

NOTE: Certain colour restrictions apply.
Please consult price list.

Decorative Base

Model **5590**

95.2 x 222.2 mm
(3 3/4" x 8 3/4")

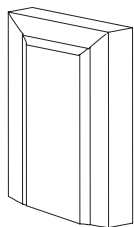

Decorative corner



Model **5531**

76.2 x 76.2 x 19 mm and
76.2 x 76.2 x 25.4 mm
(3" x 3" x 3/4" and 3" x 3" x 1")

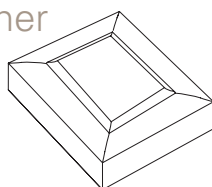

Model **5540**

95.2 x 95.2 mm
(3 3/4" x 3 3/4")

Base Board

Model **5760**



Model **5761**



Model **5762**



Height x Thickness

MODEL	mm	inches
5760	165.1 x 15.2	6 1/2 x 5/8
5761	139.7 x 15.2	5 1/2 x 5/8
5762	108 x 15.2	4 1/4 x 5/8

Casings

Model **5763**



Model **5764**



Height x Thickness

MODEL	mm	inches
5763	68.3 x 15.2	2 11/16 x 5/8
5764	79.4 x 15.2	3 1/8 x 5/8

Crown mouldings

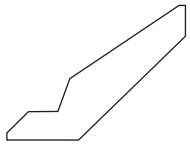

Model 718

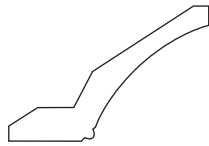

Model 719

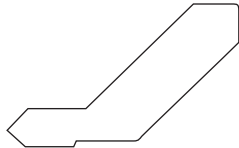

Model 721

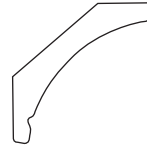

Model 722

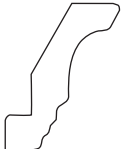

Model 741

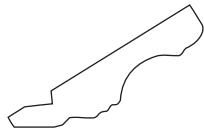

Model 743

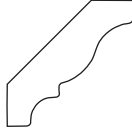

Model 745

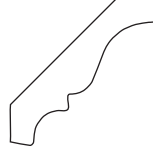

Model 746

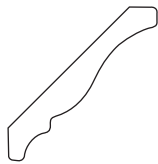

Model 751

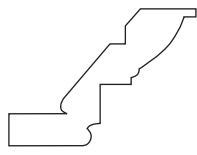

Model 756

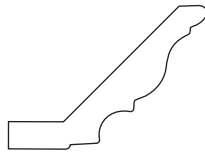

Model 757

Height x Thickness

MODEL	mm	inches
718	99.1 x 24.6	3 15/16 x 3 1/32
719	99.1 x 25	3 15/16 x 1
721	65.1 x 19.1	2 9/16 x 3/4
722	102.25 x 31.71	4 x 3/4
741	76.2 x 17.5	3 x 11/16
743	90.5 x 17.5	3 9/16 x 11/16
745	69.9 x 17	2 3/4 x 43/64
746	80.2 x 17.5	3 5/32 x 11/16
751	108 x 15	4 1/4 x 19/32
756	88.9 x 19.1	3 1/2 x 3/4
757	139.7 x 30	5 1/2 x 1 11/64

LENGTHS AVAILABLE

- 2.4 m (8'): all models, all colours

BULK PACKAGING

MODEL	PIECES/BOX
722-741-743-745-746	4
756-757	2

NOTE: Certain colour restrictions apply. Please consult price list.

3" Standard Valances

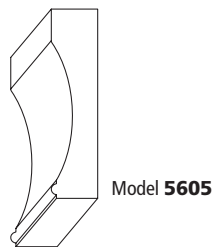
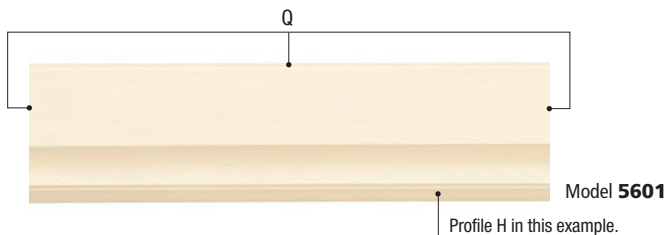

SPECIFICATION

- 1) Standard valances are 76.2 mm (3") high with one long edge profile.
- 2) All exterior profiles available. (See page 3 for profile details)
- 3) 5601, 5602 (shaped 2 sides) = 76.2 m (96")
- 4) Horizontal woodgrain by default.
- 5) To order profiled fillers, base mouldings or valances, order 2000 and 3000 product.

INSTALLATION

METHOD 1

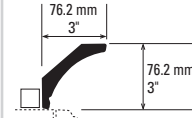

Model 722

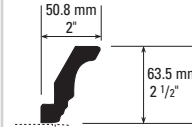

Model 741

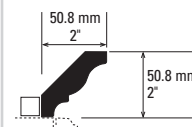

Model 745

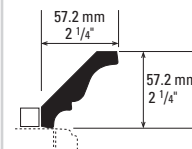

Model 746

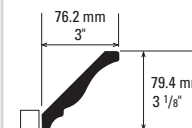

Model 751

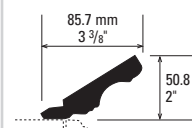

Model 743

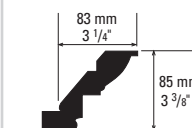

Model 756

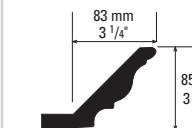

Model 757

METHOD 2

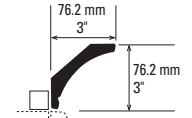

Model 722

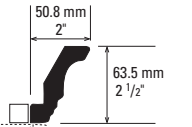

Model 741

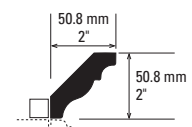

Model 745

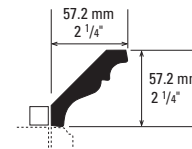

Model 746

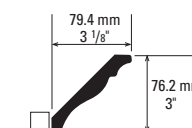

Model 751

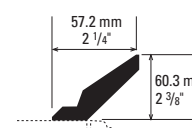

Model 5718

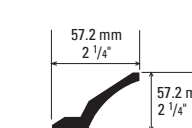

Model 5719

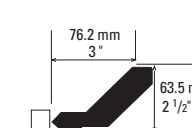

Model 721

SPECIFICATION

Nailing strips should be glued and clamped rather than nailed.

Custom Valances

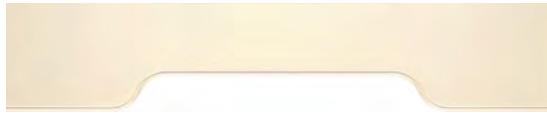

Model **5610**
Colour: C72R



Model **5620**
Colour: C72R



Model **5631**
Colour: C72R



Model **5640**
Colour: C72R



Model **5650**
Colour: C72R

Valances (Designer Series)



Model **5510**
Country Manor

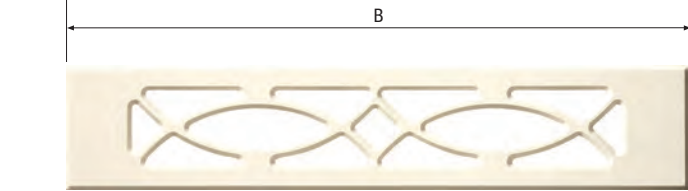

Model **5520**
Country Cottage

MODEL	Minimum sizes				Standard sizes			
	A		B		A		B	
	mm	in.	mm	in.	mm	in.	mm	in.
5510 Country Manor	152	6	235	9 ¼	152	6	762	30
5520 Country Cottage	"		304,8	12	"		762	30

SPECIFICATIONS

- 1) Back routing is identical to frame and mullion doors.
- 2) Model 5520 "Eye Shaped" pattern repeated every 355.6 mm (14").
- 3) All profiles available except D, F, H and P.
- 4) If width < 44", woodgrain direction parallel to height
- 5) If width > 44", woodgrain direction parallel to width.

Standards

Custom valance standards have been established as shown below. Therefore, custom valances ordered outside of these standards will be considered as a special programming orders.

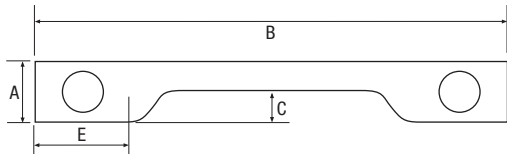

Models **5610-5611-5616**

- If **B** < 609.6 mm (24"), **E** = 76.2 mm (3")
- If **B** ≥ 609.6 mm (24"), **E** = 152.4 mm (6")
- If **A** < 203.2 mm (8"), **C** = 50.8 mm (2")
- If **A** ≥ 203.2 mm (8"), **C** = 101.6 mm (4")

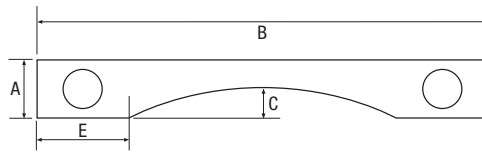

Models **5620-5621-5626, 5630-5631-5636**

- E** is variable
- If **B** < 508 mm (20"), **E** minimum size is 76.2 mm (3") and **E** maximum size is 101.6 mm (4")
- If **B** ≥ 508 mm (20"), **E** minimum size is 76.2 mm (3") and **E** maximum size is 165.1 mm (6 ½")
- If **A** < 203.2 mm (8"), **C** = 50.8 mm (2")
- If **A** ≥ 203.2 mm (8"), **C** = 101.6 mm (4")

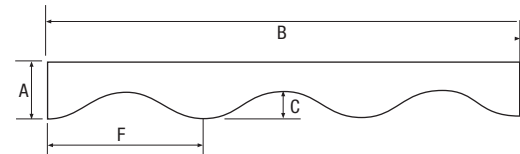

Model **5640**

- If **B** < 762 mm (30"), **F** = 127 mm (5") and **C** = 25.4 mm (1")
- If **B** ≥ 762 mm (30"), **F** = 254 mm (10") and **C** = 50.8 mm (2")

MODEL	A		B	
	mm	in.	mm	in.
5610 plain	101.6	4	330.2	13
5611 with 2 routed circles	101.6	4	330.2	13
5616 with 2 applied rosette	101.6	4	330.2	13
5620 plain	101.6	4	304.8	12
5621 with 2 routed circles	101.6	4	304.8	12
5626 with 2 applied rosette	101.6	4	304.8	12
5630 plain	101.6	4	304.8	12
5631 with 2 routed circles	101.6	4	304.8	12
5636 with 2 applied rosette	101.6	4	304.8	12
5640 plain	101.6	4	254	10
5650 plain	101.6	4	152.4	6

SPECIFICATIONS

- 1) Only the bottom edge is profiled. Please specify the edge profile.
- 2) Rosettes are centred vertically in the **A** dimension and horizontally in the **E** dimension.
- 3) Woodgrain pattern is parallel to width. (Certain exceptions may apply, please contact a Customer Service Representative for further information.)

Rosettes

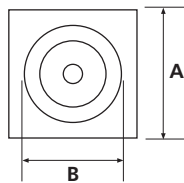

Model **5530**
Colour: C72R

Model **5580**
Colour: C72R

INTERIOR PROFIL

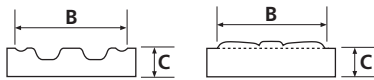

SPECIFICATIONS

- 1) The following edge profiles are not available: **H, P** and **V**.
- 2) All other profiles except **Q** and **Y** require 88.9 mm (3 1/2") minimum.
- 3) Available with white backs only.

Dimensions standards				
MODEL	A		C	
	mm	in.	mm	in.
5530 circle route	76.2	3	68	2 11/16
5580 applied rosette	76.2	3	63.5	2 1/2
			19.1 - 25	3/4 - 1

3" Radius Corners



Model **5300**

Model **5301**

Model **5302**

Model **5304**

Standard lengths
800 mm (31 1/2")

Model **5310**

Model **5311**

Model **5312**

Model **5314**

Standard lengths
2440 mm (96")

SPECIFICATIONS

- 1) Standard lengths: 800 mm (31 1/2"), 2440 mm (96"). Custom lengths also available as an option.
- 2) 800 mm (31 1/2") standard: the groove begins 57.2 mm (2 1/4") from one end. It is designed to compliment a 762 mm (30") door.
- 3) 2440 mm (96") standard: the groove begins 57.2 mm (2 1/4") from both ends.

Shaker Filler



Model **5450**

SPECIFICATIONS

- 1) Default, edge profile will be **Q**.
- 2) The following edge profiles are not available: **H, P** and **V**.
- 3) Different lengths are available for **A** and **C**.

STANDARD SIZES				
MODEL	A		C	
	mm	in.	mm	in.
5450	76.2	3	813	32

Fillers



SPECIFICATIONS

- 1) By default, the edge profile will be **Q**.
- 2) The following edge profiles are not available: **H, P** and **V**.
- 3) Unless otherwise specified, default ratio is one groove per inch of width.
- 4) Different length available for **A, B, C, D, E** on request.

INTERIOR PROFILE

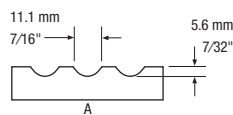

NOTE: If C is < 609.6 mm (24")

B = 38.1 mm (1 1/2")

D = 101.6 mm (4")

E = 25.4 mm (1")

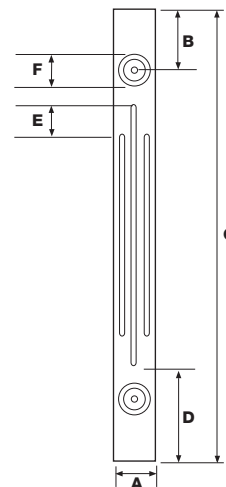

STANDARD SIZES													
MODEL	DESCRIPTION	A		B		C		D		E		F	
		mm	in.	mm	in.	mm	in.	mm	in.	mm	in.	mm	in.
5400	plain	76.2	3	-	-	813	32	-	-	-	-	-	-
5401	with 2 routed circles	76.2	3	114.3	4 1/2	813	32	-	-	-	-	68	2 11/16
5406	with 2 applied rosettes	76.2	3	114.3	4 1/2	813	32	-	-	-	-	63.5	2 1/2
5410	1 staggered groove	76.2	3	-	-	813	32	-	-	50.8	2	-	-
5411	1 staggered groove with 2 routed circles	76.2	3	114.3	4 1/2	813	32	177.8	7	50.8	2	68	2 11/16
5416	1 staggered groove with 2 applied rosettes	76.2	3	114.3	4 1/2	813	32	177.8	7	50.8	2	63.5	2 1/2
5420	2 grooves	76.2	3	-	-	813	32	177.8	7	-	-	-	-
5421	2 grooves with 2 routed circles	76.2	3	114.3	4 1/2	813	32	177.8	7	-	-	68	2 11/16
5426	2 grooves with 2 applied rosettes	76.2	3	114.3	4 1/2	813	32	177.8	7	-	-	63.5	2 1/2
5429	full length grooves	76.2	3	-	-	813	32	-	-	-	-	-	-
5430	3 grooves	76.2	3	-	-	813	32	177.8	7	-	-	-	-
5431	3 grooves with 2 routed circles	76.2	3	114.3	4 1/2	813	32	177.8	7	-	-	68	2 11/16
5436	3 grooves with 2 applied rosettes	76.2	3	114.3	4 1/2	813	32	177.8	7	-	-	63.5	2 1/2
5439	3 full length grooves	76.2	3	-	-	813	32	-	-	-	-	-	-

Ornaments applied to accessories

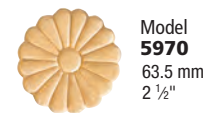

Model **5970**
63.5 mm
2 1/2"



Model **5972***
44.5 x 133.4 mm
1 3/4" x 5 1/4"



Model **5974***
50.8 x 264 mm
2" x 10 3/8"



Model **5978**
88.9 x 408 mm
3 1/2" x 16 1/8"



Model **5980**
31.8 x 243 mm
1 1/4" x 9 5/8"

* Available in pairs only.

Heatshield Fillers

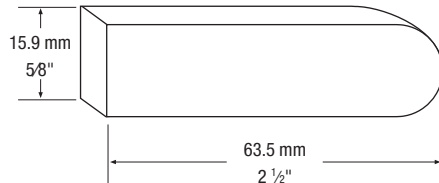
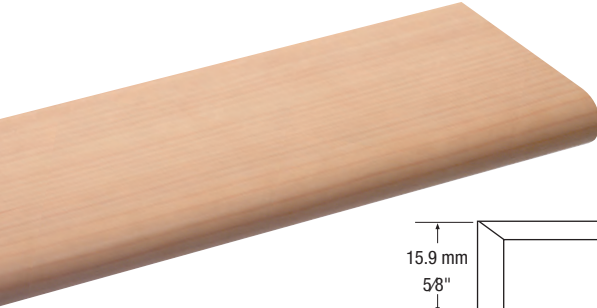

Heatshield fillers are higher heat resistant fillers for kitchen cabinet installations where heat sources are a concern.

HPL Heatshield fillers are pretested to temperatures above 120 °C (250 °F) without delamination, the HPL Heatshield Fillers are postformed 180° profiled components.

Produced with compatible HPL, they are available in most colours. Please contact a Customer Service Representative for an up-to-date list of available colours.

LENGTHS AVAILABLE SPECIFICATION

- 1.2 m (4') (5315)
- 2.4 m (8') (5316)

Each length is supplied with a 25.4 mm (1") edgebanding strip. After cutting the heatshield filler to size, use the edgebanding strip to finish the ends.

Installation

CLEAR PLASTIC HEATSHIELD FILLERS

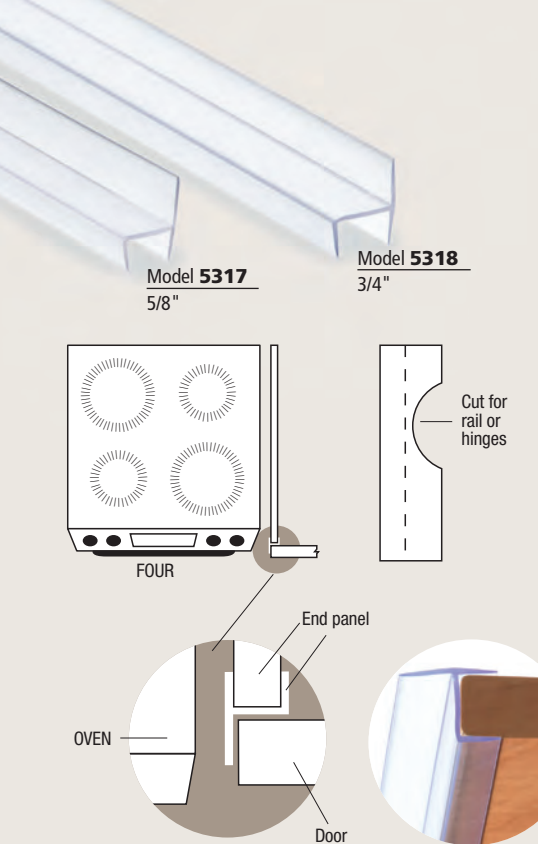

WALL MOUNTED OVENS

Heatshield fillers as mentioned in base ovens and cook tops section, are recommended. In addition, a horizontal filler should be placed above oven units, with a 5/8"–3/4" horizontal lip, mounted just below the doors above the unit; again flush with, or slightly beyond, the face surfaces of the doors.

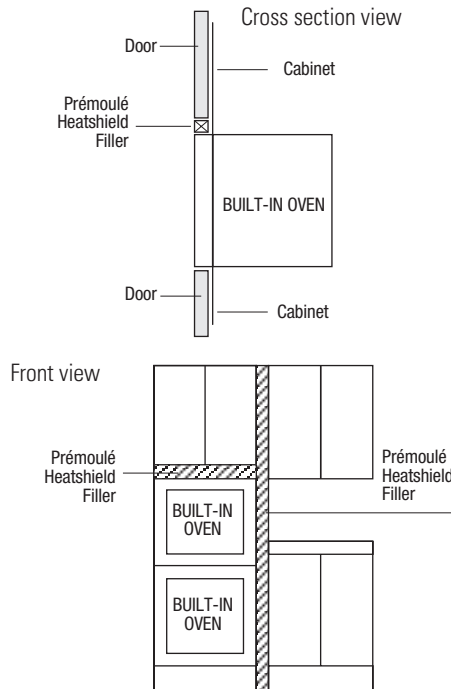

BASE OVENS AND COOK TOPS

The heatshield filler mounted so that the face is flush with adjoining door parts. The same recommendation applies to cook tops with front exhaust vents; fillers, so mounted, provide a barrier to shield excessive radiant and convective heat associated with broiling, with the door slightly opened; as well as, with ovens equipped with "Self Cleaning" features.

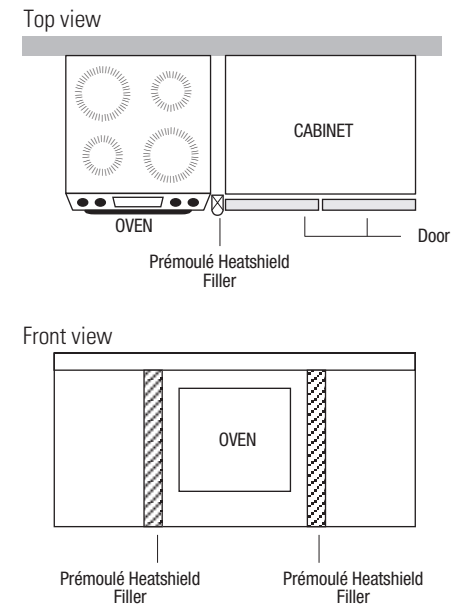

The clear plastic heatshield is a great option for cabinet installation close to a heat source. With the same resistance to heat as the HPL Heatshield fillers (250 °F / 120 °C), this clear plastic heatshield is compatible with all thermoplastic colours. It is easily installed along the edge of the end panel and requires no adhesive. If installing the heatshield around hinges or rails, a simple cut on the interior of the heatshield is sufficient.

WALL MOUNTED MICROWAVE OVENS AND UNDERMOUNT COFFEE MAKERS

The heatshield filler mounted flush, or protruding slightly beyond the face surfaces of doors above, is recommended. This precludes possible surface damage and swelling of core material from excessive heat and/or steam.

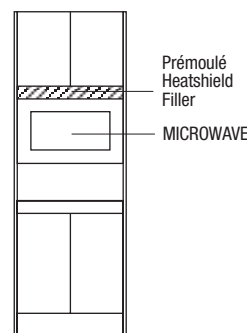

RESTRICTION

Counter top appliances: Care must be taken when using toasters, toaster ovens, portable grills and other heat/steam generating appliances to ensure that upper cabinet doors are not subjected to excessive temperatures

Corner Shelves

SHELF WITH RADIUS



Model **5120**

NOTE: Available same colour back.

SHELF WITH ELLIPSE



Model **5121**

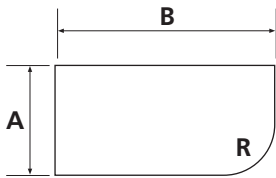

If **A** or **B** < 203.2 mm (8"),
R = 88.9 mm (3 1/2")

If **A** and **B** ≥ 203.2 mm (8"),
R = 190.5 mm (7 1/2")

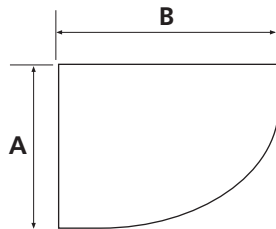

If **A** or **B** sizes are between:

101.6 mm (4") – 152.4 mm (6"),
R = 101.6 mm (4")

152.4 mm (6") – 203.2 mm (8"),
R = 152.4 mm (6")

203.2 mm (8") – 254 mm (10"),
R = 203.2 mm (8")

254 mm (10") – 381 mm (15"),
R = 254 mm (10")

NOTE: Minimum size for **A** and **B**
is 89 mm (3 1/2")

End Panels

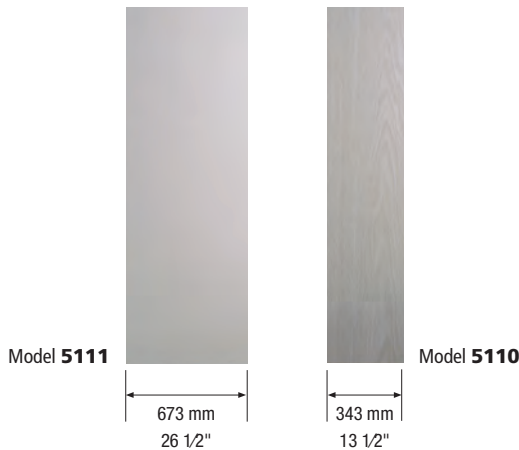

Sizes available

- 343 mm x 2440 mm (13 1/2" x 96")
All exterior profiles available 5110 (1 side),
5116 (2 sides)
- 673 mm x 2440 mm (26 1/2" x 96")
All exterior profiles available 5111 (1 side),
5117 (2 sides)
- Custom sizes also available.

Edgebanding

Our thermoplastic edgebanding is formulated to be used with edgebanding machines operating at 77 °C (170 °F). Since standard edgebanding machines run at 88 °C (190 °F) to 99 °C (210 °F), we also offer PVC edgebanding which can be applied with the standard machines. Available finishes for each type of edgebanding are listed in the table on page 51-52.

Thermoplastic Edgebanding

- 25.4 mm (1") wide
- 100 m (328') roll (5008)
- 2.4 m (8') length (5009)

PVC Edgebanding

- 23.8 mm (1 5/16") wide
- 236.2 m (600') roll (5050)

SPECIFICATIONS

- 1) Our warranty is applicable on thermoplastic products and does not apply to PVC edgebanding.
- 2) For manual application, a premium grade water-based contact cement should be used.

Decorative Tambours

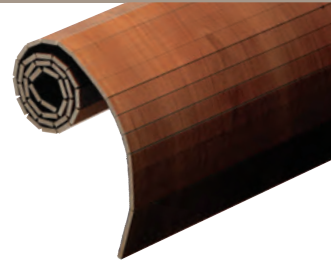

Sizes available

	3,2 mm (1/8")	6,4 mm (1/4")
• 0.6 m x 0.6 m (2' x 2')	5005	5055
• 0.6 m x 1.2 m (2' x 4')	5003	5052
• 1.2 m x 1.2 m (4' x 4')	5004	5054

SPECIFICATIONS

- 1) Strip size: 12.7 mm (1/2")
Initial strip: 38.1 mm (1 1/2")
- 2) Thickness:
 - 3.2 mm (1/8")
 - 6.4 mm (1/4")
- 3) Standard: vertical woodgrain.
Horizontal woodgrain available as an option.

Thermoplastic Foil Sheeting

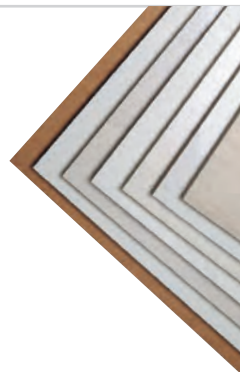

Foil Sheets

- 1.2 m (4') wide (5000)

Peel and Stick

- 1.2 m x 2.4 m (4' x 8') (5040)

Thermoplastic on phenolic

- 1.2 m x 2.4 m (4' x 8') (5060)

Laminated Panels – Unilam (Chipboard)

ONE SIDE

- 5011 : 15.86 mm x 1.2 m x 2.7 m (5/8" x 4' x 9')
- 5013 : 15.86 mm x 1.2 m x 2.4 m (5/8" x 4' x 8')
- 5015 : 19.05 mm x 1.2 m x 2.4 m (3/4" x 4' x 8')

BOTH SIDES

- 5010 : 15.86 mm x 1.2 m x 2.7 m (5/8" x 4' x 9')
- 5012 : 15.86 mm x 1.2 m x 2.4 m (5/8" x 4' x 8')
- 5019 : 19.05 mm x 1.2 m x 2.4 m (3/4" x 4' x 8')

Laminated MDF Panels

- 5014 : 6.3 mm x 1.2 m x 2.4 m (1/4" x 4' x 8')
- 5018 : 3.18 mm x 1.2 m x 2.4 m (1/8" x 4' x 8')
- 5027 : 19.05 mm x 1.2 m x 2.7 m (3/4" x 4' x 9')

Laminated MDF Panels (Both sides)

- 5017 : 19.05 mm x 1.2 m x 2.7 m (3/4" x 4' x 9')
- 5026 : 15.86 mm x 1.2 m x 2.4 m (5/8" x 4' x 8')

Laminated Melamine Panels

- 5016 : 19.05 mm x 1.2 m x 2.7 m (3/4" x 4' x 9')
- 5024 : 15.86 mm x 1.2 m x 2.7 m (5/8" x 4' x 9')
- 5025 : 15.86 mm x 1.2 m x 2.4 m (5/8" x 4' x 8')

NOTE: See table pages 51-52 for specifications and colours available.

Product Properties

Height and width tolerance

- ± 0.5 mm (0.020")

Warp tolerance per linear foot

- $\pm 0,8$ mm (1/32"). Refer to page 47 for recommended hinge holes.

Heat resistance

- 85 °C (185 °F). See page 44 for installation near heat sources.

Product Care and Maintenance

Thermoplastic doors can be easily cleaned with mild soap and water. However, as with any quality product, there are certain precautions you can take to preserve its value.

- Avoid the use of harsh chemicals, such as lacquer thinner, bleach or cleansers containing solvents or abrasives; especially avoid products containing toluene or acetone.
- Avoid bumping or hitting surface with a sharp object, since it could result in a permanent indentation or cut. In the event of abuse, minor surface scratches can sometimes be removed depending on the severity of the damage. The following is recommended:
 - 1) Rub the scratched area with a high grade polishing compound.
 - 2) Polish the area with a carnuba based wax.
 - 3) Repair kits are available from paint companies specializing in touch up paints.
- Avoid exposure of doors and drawers with high heat. To ensure against damage to doors or drawers, please do the following:
 - 1) When broiling with oven door open, open doors and drawers of adjacent cabinets to minimize exposure to high heat.
 - 2) Since the door seals on some ranges and ovens allow high heat to escape during the self cleaning cycle, as a precaution, open or remove doors and drawers of adjacent cabinets during the self cleaning cycle.
 - 3) Be aware of countertop appliances such as boilers, toasters and toaster ovens that create high heat conditions. They should not be directly under doors of overhead cabinets while in use.

Banks of drawers

We recommend ordering banks of drawers as doors rather than as reduced rail drawer fronts when they are over 228.6 mm (9") high.

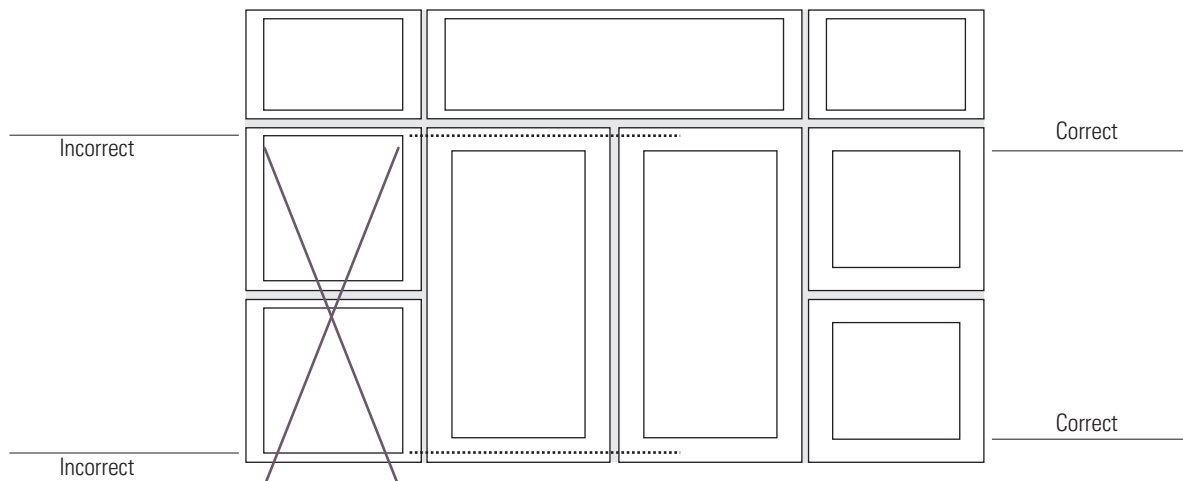

Fingerpull

The descriptive codes for fingerpull location have been simplified. (*) in the new code correspond to the exterior profiles selected. Please replace the asterisk (*) by the exterior profile letter.

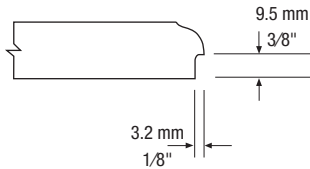

- 1) Can be added to all exterior profiles except **G, H, L, M** and **S**.
- 2) Fingerpulls 4***, *4**, **4* and ***4 will be full length – starting 25.4 mm (1") from one side and ending 25.4 mm (1") from the other side.
- 3) All other fingerpulls will be 101.6 mm (4") wide. Fingerpulls on the corners will be 25.4 mm (1") from the end.

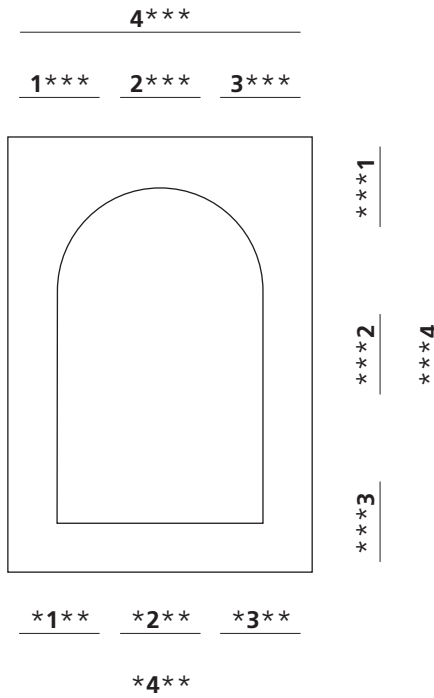

4***	Top full length
*4**	Bottom full length
**4*	Left side full length
***4	Right side full length
1***	Top left
2***	Top centre
3***	Top right
*1**	Bottom left
*2**	Bottom centre
*3**	Bottom right
**1*	Left side top
**2*	Left side centre
**3*	Left side bottom
***1	Right side top
***2	Right side centre
***3	Right side bottom

Quantity and Location of Hinges

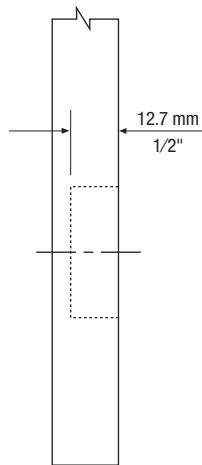
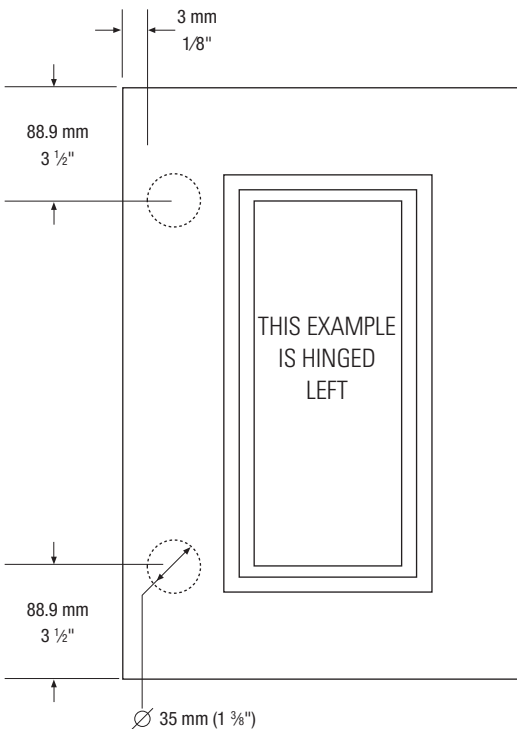

Standard hinge hole diameter: 35 mm (1 3/8")

Standard depth: 12.6 mm (1/2")

Standard location:

- for doors 254 mm (10") and over, 3 mm (1/8") from side and centred at 88.9 mm (3 1/2") from top or bottom edge of the door.
- for doors less than 254 mm (10"), 3 mm (1/8") from side and centred at 63.5 mm (2 1/2") from top or bottom edge of the door.

NOTE

For doors requiring more than 2 hinges, a drawing indicating actual position of the hinge holes is required.

DOOR HEIGHT		NUMBER OF HINGES REQUIRED
mm	inches	
0 to 899.16	0 to 35.4	2
899.17 to 1000.8	35.5 to 39.4	3
1000.9 to 1991.4	39.5 to 78.4	4
1991.5 to 2438.4	78.5 to 96	5

Minimum sizes indicated for each door model must be respected due to hinge clearance considerations.



A31S White - Super Matte



A3WT Weekend Getaway - Textured



A4WT Winter Fun - Textured



A15WT Après-ski - Textured



A24WT Dalia ambassador - Textured



A54WT Skye - Textured



A60WT Mousseline - Texturé



A61WT Soie - Texturé



A661S Moon Light - Satin



B21R White - Matte



B21W White Woodgrain - Matte

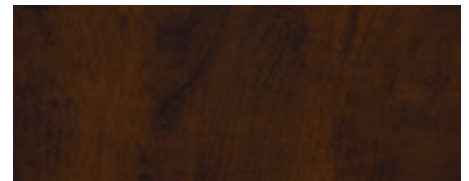

B44W Chocolate espresso - Woodgrain



B54W Designer White Woodgrain - Matte

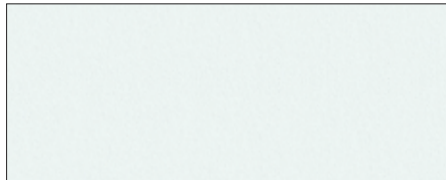

B175R Snow White - Matte



C32L Antique White - High Gloss



C35S White - Satin

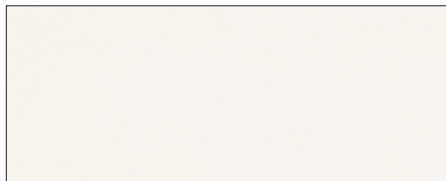

C72R Antique White - Matte

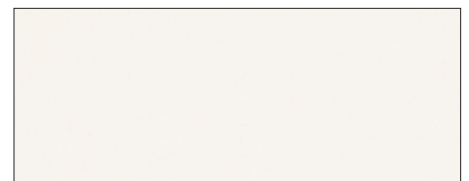

C72S Antique White - Satin

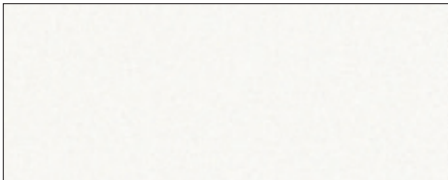

C73R Frosty White - Matte



C92W Hard Rock Maple - Matte

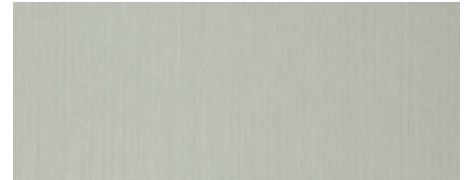

D530WT Latitude North - Textured



F20W Summer Flame - Matte



F21W Candlelight - Matte



F44W Chocolat Pear Tree - Matte

These suggested options are informational only.
For accurate colour selection we recommend that you obtain a product sample.



F432WT Taction Oak Alabaster - Satin



F434WT Taction Oak Gibraltar - Textured

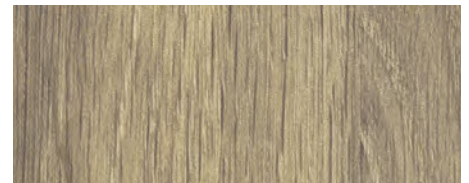

F435WT Taction Oak Palomino - Textured

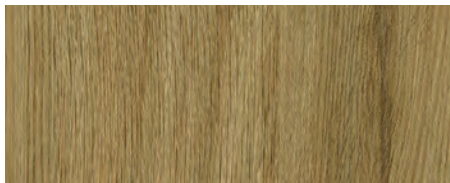

F440WT Taction Oak Ginger - Textured



K02W Sesame - Satin



K16S White - Super Matte



K75S Violet Grey - Satin



K85S Mysterious Blue - Satin



K168S Canadien Grey - Satin



K233S Gountlet Gray - Satin



K241S Sienna - Satin



K257S Verde - Satin

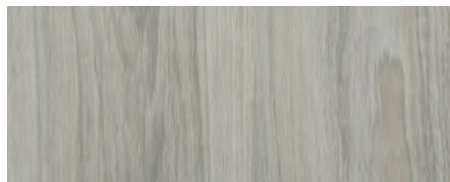

K464WT Nomade - Texturé



K503S Celadon Green - Satin



K636S Fjord - Satin



K961R Stainless Steel - Matte



P340W Aria - Matte



P472W Shiraz Cherry - Matte



P488W Dolce Vita - Matte

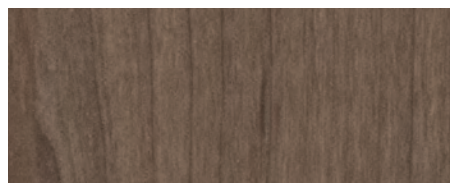

P489W Copa Cabana - Matte



P492W White Chocolate - Matte



P494W Dark Chocolate - Matte



P501WT Linear Ash - Textured



P909R Black - Matte



R32S Black - Super Matte



R42L Black - High Gloss

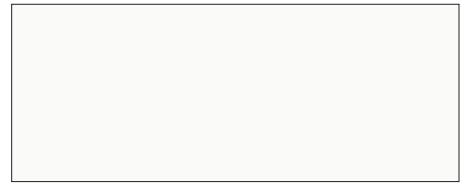

R49L White - High Gloss



R54R Designer White - Matte

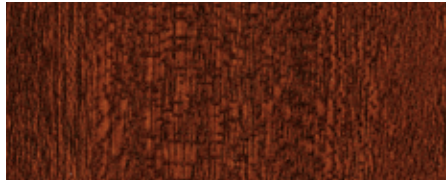

R74W Mahogany - Matte



R80S Célestine - Satin



R81S Adobe - Super Matte



R82S White Smoke - Super Matte



R83S Shipshaw - Super Matte



R89WT Cosmos - Texturé



R105S White - Super Matte



R205W Tobacco Cherry - Matte



R207W Choco Cherry - Matte

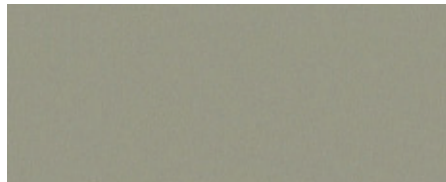

R232S Ashen - Satin

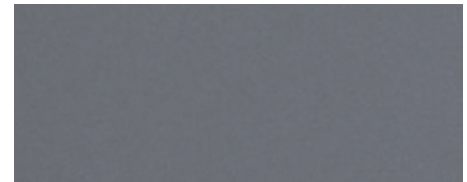

R237S Charcoal - Satin

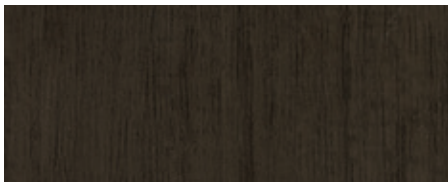

R477W-DT Tuxedo - Matte



R660S Rain Cloud - Satin



R663S Morning Dew - Satin



R766W Cayenne Maple - Matte



V66WT Whisper - Textured



V67WT Rumour - Textured

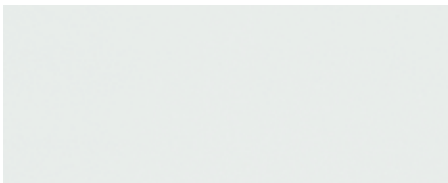

V202S Summer Drops - Satin

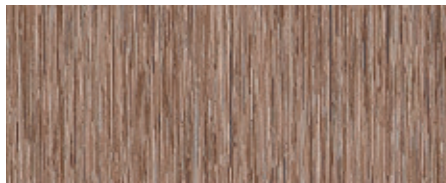

V284WT Tango Silk - Textured

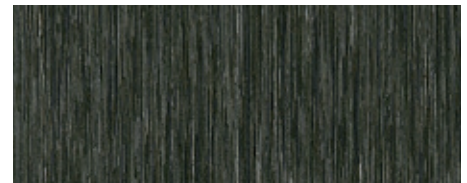

V285WT Jazz Silk - Textured

These suggested options are informational only.
For accurate colour selection we recommend that you obtain a product sample.

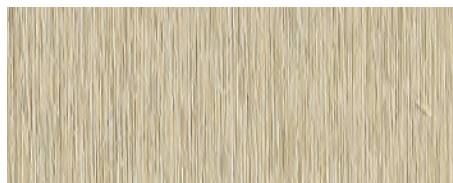

V287WT Lebelles Silk - Textured

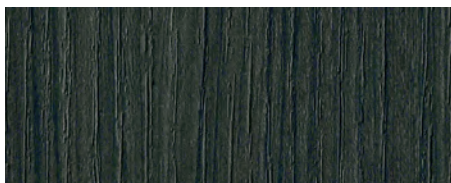

V392WT Licorice Groovz - Textured



V393WT Concrete Groovz - Textured



V394WT Artic Groovz - Textured



V521W Rustik Cherry - Matte

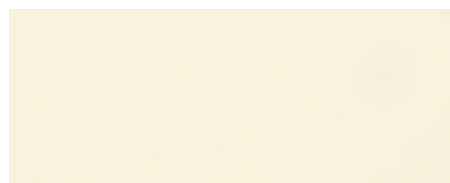

V629R Ivory - Matte



V731V Matte Luxe Viridian - Velvet

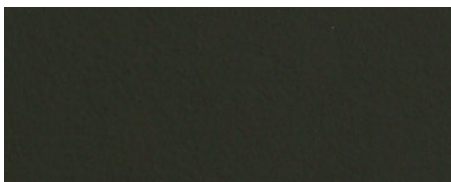

V745V Matte Luxe Black - Velvet

COLOURS AND FINISHES

PRÉMOULÉ COMPATIBLE COLOUR OPTIONS

Colour	Description	Colour Group	Colour Back	Foil with Peel & Stick	Melamine	HPL	Thermo Edge-banding	PVC Edge-banding
A31S	White - Super Matte	B	White - matte	●	Uniboard 555			●
A3WT	Weekend Getaway - Textured	B-C	●	●	Tafisa M2003 (Y)	T2003 VA*		●
A4WT	Winter Fun - Textured	B-C	●	●	Tafisa M2004 (Y)	T2004 VA*		●
A15WT	Après-ski - Textured	B-C	●	●	Tafisa M2015 (Y)	T2015 VA*		●
A24WT	Dalia ambassador - Textured	B-C	●	●	Uniboard K24	Formica 0UK24-NT*		●
A54WT	Skye - Textured	B-C	●	●	Uniboard H54	Formica 0UH54-BT*		●
A60WT	Chiffon - Textured	B-C	●	●	Uniboard K60			●
A61WT	Silk - Textured	B-C	●	●	Uniboard K61			●
A661S	Moon Light - Satin	B-C	●	●	Tafisa L761	Arborite T761-KR*		●
B21R	White - matte	A	White - matte	●	Arauco W400 Panolam S411 Tafisa L080	Wilsonart D427-60*	●	●
B44W	Chocolate Pear Tree – Matte	B-C	●	●	Tafisa L4444	Arborite W4444-CA**	●	●
B54W	Designer White Woodgrain - matte	A	White - matte	●			●	
B175R	Snow White - matte	B		●	Uniboard 5555 Panolam S557	Formica 949-58		●
C32L	Antique White - high gloss	F	Matte			Formica 932-90 Wilsonart 1572-F1*	●	●
C35S	White - satin	D	White - matte	●			●	●
C72R	Antique White - matte	A-AA	●	●	Panolam S463 Uniboard 810	Formica 932-58 Wilsonart 1572-60 Arborite S463-CA	●	●
C72S	Antique White - satin	D-E	Matte	●	Panolam S463 Uniboard 810	Wilsonart 1572-7	●	
C73R	Frosty White - matte	A	White - matte	●	Arauco W100	Wilsonart 1573-60*	●	●
C92W	Hard Rock Maple - matte	B-C	●	●	Panolam W290 Uniboard 992	Formica 86992-58* Pionite WM791N Wilsonart 10776-60	●	●
D530WT	Latitude North - Textured	B-C	●	●	Tafisa L530	Arborite T530-AT		●
F21W	Candlelight - matte	B-C	●	●	Panolam W334 Uniboard 262 Tafisa L421	Arborite W421-CA*	●	●
F432WT	Taction Oak Alabaster - Textured	B-C	●	●	Arauco WF432			●
F434WT	Taction Oak Gibraltar - Textured	B-C	●	●	Arauco WF434	Formica WF434-NG		●
F435WT	Taction Oak Palomino - Textured	B-C	●	●	Arauco WF435	Formica WF435-NG		●
K02W	Sesame - Satin	B-C	●	●	Uniboard K-02	Formica 0UK02-NT*		●
K16S	White - Super Matte	B		●	Arauco W100			●
K75S	Violet Grey - Satin	B		●				●
K85S	Mysterious Bleu - Satin	B-C	●	●	Arauco SF247			
K168S	Canadien Grey - Satin	B-C	●	●	Uniboard 168	Formica OU168		●
K233S	Gountlet Grey - Satin	B-C	●	●	Arauco SF233	Arauco FB2330-S		●
K241S	Sienna - Satin	B-C	●	●	Arauco SF230	Arauco FB4300-S		●
K257S	Verde - Satin	B-C	●	●	Arauco SF257			●
K464WT	Urban Nomad - Textured	B-C	●	●	Arauco WF464			●
K503S	Celadon Green - Satin	B	●	●	Arauco SF251			●
K636S	Fjord - Satin	B		●				●

* Stock Prémoulé

Shaded colour code indicates same colour back available. All other colours with white back. The ultimate responsibility rests solely with the end user with respect to acceptability of these options in specific applications.

Colour	Description	Colour Group	Colour Back	Foil with Peel & Stick	Melamine	HPL	Thermo Edge-banding	PVC Edge-banding
K961R	Stainless Steel - Matte	D-E	●	●	Panolam A60 Uniboard 961	Formica U961-58*	●	●
P488W	Dolce Vita - Matte	B-C	●	●	Tafisa L488	Arborite T488-CA*		●
P489W	Copa Cabana - Matte	B-C	●	●	Tafisa L489	Arborite T489-CA		●
P492W	White Chocolate - Matte	B-C	●	●	Tafisa L492	Tafisa T492-CA*		●
P494W	Dark Chocolate - Matte	B-C	●	●	Tafisa L494	Tafisa T494-CA*		●
P501WT	Linear Ash - Textured	B-C	●	●	Arauco WF368	Arauco FB3680-S		●
P909R	Black - Matte	A-AA	Black - matte		Uniboard 888	Formica 909-58*	●	
R32S	Black - Super Matte	B-C	Black - matte	●	Uniboard 888			●
R42L	Black - High Gloss	F	Black - matte			Arborite S405-GL Formica 909-90* Wilsonart 1595-F1		●
R49L	White - High Gloss	F	Matte			Nevamar S7032G Wilsonart 1573-F1*	●	●
R54R	Designer White - Matte	A	White - matte	●	Panolam S645	Wilsonart D354-60*	●	●
R74W	Mahogany - Matte	B-C	●	●			●	●
R80S	Celestine - Satin	B-C	●	●	Uniboard K80			●
R81S	Adobe - Super Matte	B	●	●	Uniboard K81		●	●
R82S	White Smoke - Super Matte	B-C	●	●	Uniboard K82		●	●
R83S	Shipsaw - Super Matte	B-C	●	●	Uniboard K83		●	●
R89WT	Cosmos - Textured	B-C	●	●	Uniboard K89			●
R105S	White - Super Matte	B		●	Tafisa L105			●
R205W	Tobacco Cherry - Matte	B-C	●	●	Uniboard 205 Tafisa L805	Formica U205-58*	●	●
R207W	Choco Cherry - Matte	B-C	●	●	Uniboard 207 Tafisa L807	Formica U207-58*	●	●
R232S	Ashen - Satin	B-C	●	●	Arauco SF232	Arauco SF232		●
R237S	Charcoal - Satin	B		●	Arauco SF237			●
R477W-DT	Tuxedo - Matte	B-C	●	●	Tafisa L477	Arborite T477-CA*		●
R660S	Rain Cloud - Satin	B-C	●	●	Tafisa L760	Arborite T760-CA*		●
R663S	Morning Dew - Satin	B-C	●	●	Tafisa L763	Arborite T763-CA*		●
V66WT	Whisper - Textured	B-C	●	●	Uniboard K66			●
V67WT	Rumour - Textured	B-C	●	●	Uniboard K67			●
V202S	Summer Drops - Satin	B-C	●	●	Tafisa L202			●
V284WT	Tango Silk - Textured	D		●				●
V285WT	Jazz Silk - Textured	D		●				●
V392WT	Licorice Groovz - Textured	B-C	●	●	Arauco WF392	Arauco WF392-NG		●
V393WT	Concrete Groovz - Textured	B-C	●	●	Arauco WF393	Arauco WF393-NG		●
V629R	Ivory - Matte	A-AA	●	●	Tafisa L204	Arborite T204-CA*	●	●
V731V	Matte Luxe Viridian - Velvet	B		●				●
V745V	Matte Luxe Black - Velvet	B		●				●

* Stock Prémoulé

HIGH BRILLIANCE COLLECTION

REFINEMENT AND ELEGANCE

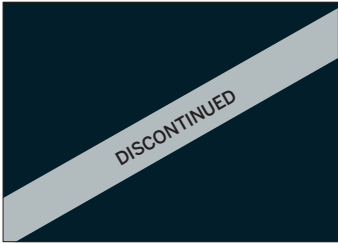

H111L Midnight Bleu

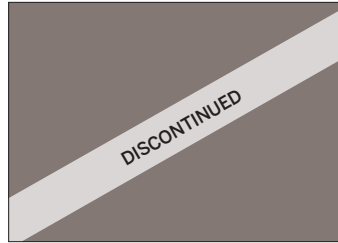

D40L Stone Brown



A96L Steel HG



H110L Taupe HG

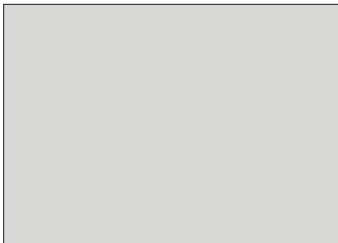

H109L Grey HG



K101L Maranello Red



H106L Orange



H104L Olive



H108L Exotic Ebony



R49L White HG*

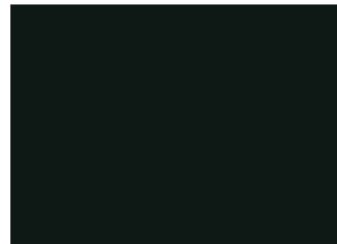

R42L Black HG*

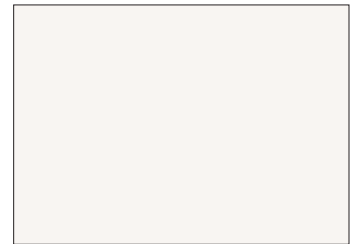

C32L Antique white HG*

Due to the Unilam cold-press process, the gloss's sheen may vary from doors. A sample is recommended.

For more information, refer to our *Thermoplastic Custom Program brochure*.

Available profiles:

Slab models only: I, J, K, L, M, Q, Y, 6 profiles.

Colour Groups High Gloss Finishes:

Solid Colours: F

Patterned Colours: G

Unilam and Peel & Stick options available.

PVC edgbanding available for the following: C32L, H106L, H108L, H109L, H110L, R42L and R49L.

* Also offered in the regular program.

HIGH BRILLIANCE OPTION

Thanks to new state-of-the-art technology of our new press, our high gloss finish colours will now be available with a HIGH BRILLIANCE option, I, J, K, L, M, Y and 6 profiles (slab 00 models) will automatically be produced as such.

CERTIFICATE OF
WARRANTY

10 YEARS

APPLICABLE TO THERMOPLASTIC PRODUCTS
Starting on January 1st 2011 (see conditions on reverse)

Distributor

Invoice #

Date of purchase



CERTIFICATE OF WARRANTY

1. General Terms and Conditions

Prémoulé guarantees its thermoplastic products which are distributed and sold through an authorized distributor.

The installation should only be done by an experienced professional. It is also the responsibility of the person installing the product to determine its suitability for a particular application.

Prémoulé guarantees its products against yellowing, delamination or any apparent or hidden defect that might affect their quality or cause premature deterioration. The following conditions apply:

2. Duration

This guarantee is valid for a period of 10 years following the date of purchase.

3. Exclusions

This guarantee does not apply:

3.1 When damages are caused:

- by misuse or abuse of the product by the buyer
- by improper installation or exposure to the elements
- by any modification, transformation, or correction of the product without a written authorization from Prémoulé;
- by improper storage;
- by any indirect damage (including incidentals, special or consequential damages);
- by exposure to a temperature over 85 °C (185 °F)

3.2 To any deterioration of the product resulting from normal wear and tear.

3.3 To any damage or incident relating to the costs of installation and transportation, or any other costs relative to the application of this guarantee.

4. Scope

This guarantee is unassignable and constitutes the only guarantee offered by Prémoulé.

There is no guarantee of merchantability or fitness for specific purposes other than the guarantee detailed above. Prémoulé makes no other guarantee whatsoever, expressed or implied, oral or written.

5. Execution of Guarantee

For the duration of this guarantee, in order to exercise his rights, the buyer shall notify as soon as possible the authorized distributor or PRÉMOULÉ of any defect in the product and shall provide proof of purchase or the back of this present certificate properly completed. The buyer shall not make any repairs before the authorized distributor has had an opportunity to examine the product and its installation.

When this guarantee is applicable, Prémoulé may repair its products, provide replacement products or, at its sole option, offer the reimbursement of the purchase price.

6. Authorized Distributor

Only an authorized Prémoulé distributor may, in compliance with the terms and conditions of this guarantee, assume the obligations contained herein after obtaining prior authorization from Prémoulé. The authorized distributor is not mandated by Prémoulé to modify or extend the scope of this guarantee.

Distributed by

2375, avenue Dalton, bureau 200
Québec (Québec) Canada G1P 3S3

T 418 652-7777 | 1 866 652-7777
F 418 652-7558 | 1 866 652-7558
info@premoule.com

premoule.com

Photography in this leaflet is for illustration purposes only. Actual color may vary slightly due to the printing process. For accurate color selection we recommend that you obtain a product sample.

Prémoulé supports

